



# INSTALLATION MANUAL

---

## PROFESSIONAL SERIES PENDANT

PS-P43T | PS-P63T | PS-P83T | PS-P83WT

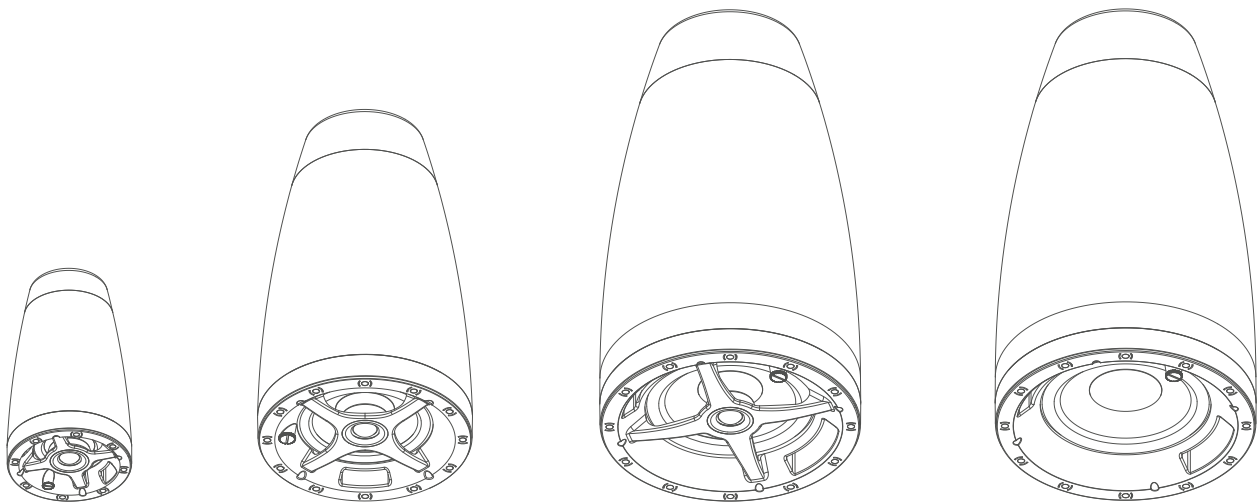

# TABLE OF CONTENTS

PRODUCT DESCRIPTION	2
BOX AND CONTENTS	2
PRODUCT FEATURES	3
PRODUCT PREPARATION	
Amplifier Selection	4
Wire Selection	
70V/100V System	4
8 ohm System	4
Speaker Placement	4
Grille Painting	5
INSTALLATION	6
TECHNICAL SPECIFICATIONS	
PS-P43T	8
PS-P63T	9
PS-P83T	10
PS-P83WT	11
CERTIFICATIONS & SAFETY AGENCY	12
TECHNICAL ASSISTANCE & SERVICE	12
WARRANTY	13

## PRODUCT DESCRIPTION

From Sonance, the company that created the architectural audio category comes a range of professional loudspeakers that set a new benchmark in sound quality and aesthetics for commercial environments.

Introducing Sonance **Professional Series**

Sonance Professional Series includes a range of In-Ceiling, Pendant and Surface Mount speakers that deliver true full range fidelity, extremely low distortion, wide dispersion and a smooth power response. The range also shares consistent voicing, ensuring seamless sonic integration when used together throughout a space.

The Pendant speakers utilize a minimalistic design similar to pendant lighting to blend discretely into the environment, and take advantage of the same one-piece grille design as the In-Ceiling speakers to deliver consistent sight lines when installed in the same space. The integrated top cover hides the hanging hardware and wiring connector. Available in 4", 6.5" and 8" 2-Way and 8" Woofer in either black or white.

## BOX & CONTENTS

### 2-WAY SPEAKERS

- (2) PS-P43T, or PS-P63T, or PS-P83T
- (2) Speaker Grille
- (2) Screw-On Top Cover
- (2) Hanging Kits Containing:
  - (4) Stainless Steel Cables with Snap Hooks
  - (4) Gripple® Hangers
  - (2) Gripple® Adjustment Tools
  - (2) Hanging Instructions

### WOOFER

- (1) PS-P83WT
- (1) Speaker Grille
- (1) Screw-On Top Cover
- (1) Hanging Kit Containing:
  - (2) Stainless Steel Cables with Snap Hooks
  - (2) Gripple® Hangers
  - (1) Gripple® Adjustment Tool
  - (1) Hanging Instruction

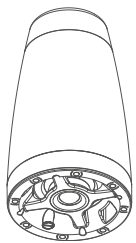

**PS-P43T**  
4" 2-Way

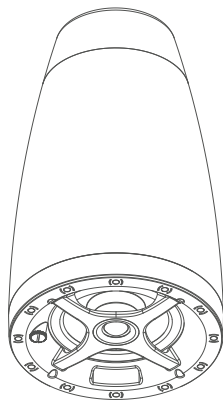

**PS-P63T**  
6.5" 2-Way

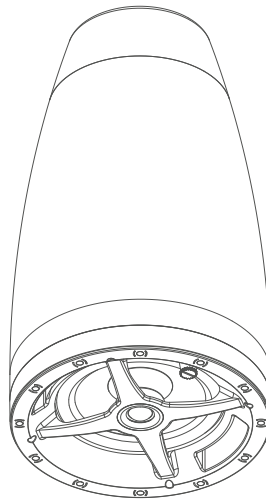

**PS-P83T**  
8" 2-Way

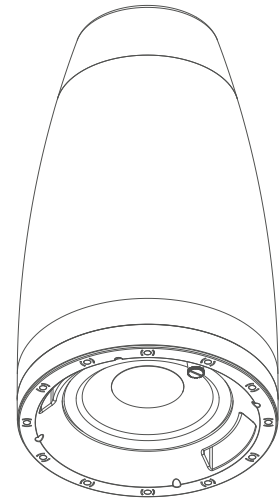

**PS-P83WT**  
8" Woofer

## PRODUCT FEATURES

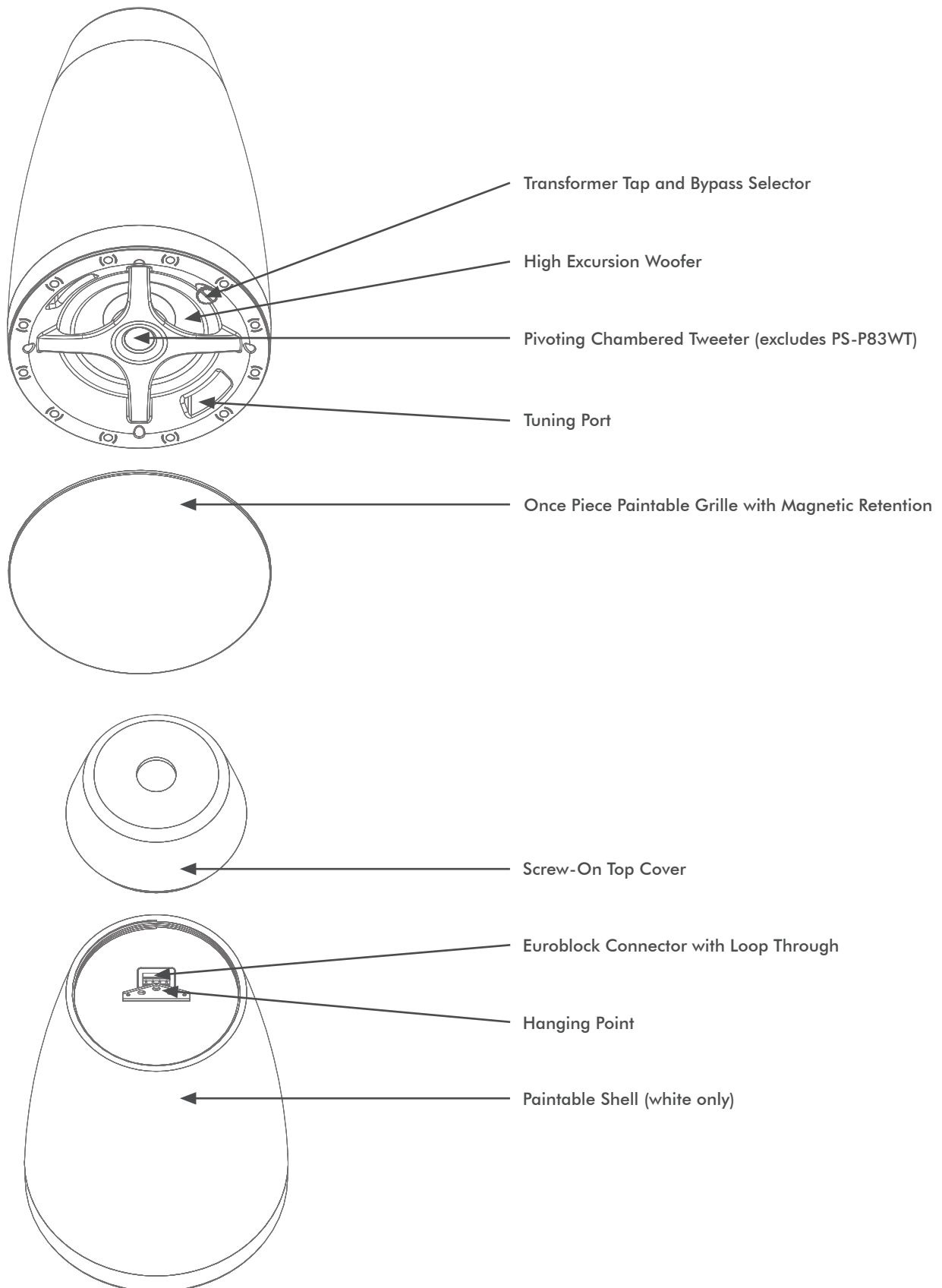

## AMPLIFIER SELECTION

When choosing an amplifier the maximum number of speakers and the output level of each speaker must be known. The sum of the tap settings should never exceed 80% of the amplifier's rated output. For example, if there are 5 speakers and the taps are set at 15 watts, the load would be 75 watts (5 x 15 watts = 75 watts). To arrive at the needed power for this number of speakers, simply divide the total load by .8. In this case,  $75 / .8 = 93.75$  watts. Therefore, a standard 100 watt amp would safely drive this load. To calculate the amount of usable power an amp offers, simply multiply the rated output by .8, i.e.,  $100 \text{ watts} \times .8 = 80 \text{ watts}$ .

## WIRE GAUGE – 70V/100V SYSTEM

The most common wire used on commercial 70 volt systems is 18 gauge, 2 conductor, stranded, and jacketed without a shield. The wire starts at the amplifier location and is paralleled at each speaker location.

Wire length using 18 gauge is appropriate up to 700 feet with a 100 watt load. If you double the load (sum of your tap settings), you will reduce the footage by half, to 350 feet. Conversely, if you halve the load, you may double the acceptable wire length, i.e., a 50 watt load is safe over 1400 feet of 18 gauge. Stepping up to 16 gauge wire extends the allowable run length by approximately 35%. For example, a 100 watt load can go 700 feet on 18 gauge; the same load may be placed on 1100 feet of 16 gauge.

## WIRE GAUGE – 8 OHM SYSTEM

When using Sonance Professional Series loudspeakers in an 8 ohm system the total wire resistance should be less than 10% of the speaker impedance. The speakers are nominally 8 ohms impedance, so your total wire resistance should be no more than 0.8 ohms.

In simple terms, the extra resistance from the wire will have a very negative affect on the sound quality of the speaker. The sound can be less dynamic, definition of bass frequencies can be reduced, and in extreme cases, the high frequencies can be attenuated. Amplifier power is also wasted in the wire, reducing the maximum output level of the system.

Please refer to the following chart (see figure 1) when deciding on the appropriate wire gauge for your installation.

Wire Resistance in Ohms vs. Length of Cable Run						
Distance in Feet	50'	100'	150'	200'	250'	300'
20 Gauge	.86	1.73	2.59	3.45	4.32	5.18
18 Gauge	.65	1.30	1.94	2.59	3.24	3.89
16 Gauge	.43	.85	1.28	1.71	2.14	2.56
14 Gauge	.27	.54	.81	1.08	1.35	1.62
12 Gauge	.17	.34	.51	.68	.85	1.02

FIGURE 1: WIRE RESISTANCE

## SPEAKER PLACEMENT

Sonance Professional series speakers possess extremely smooth and predictable off-axis frequency response. The chart below (see figure 2) shows how far apart the speakers can be placed in a distributed audio system. The calculations are based on +/- 45 degrees of coverage from the speaker, and listener ear heights of 62" for standing and 40" for seated.

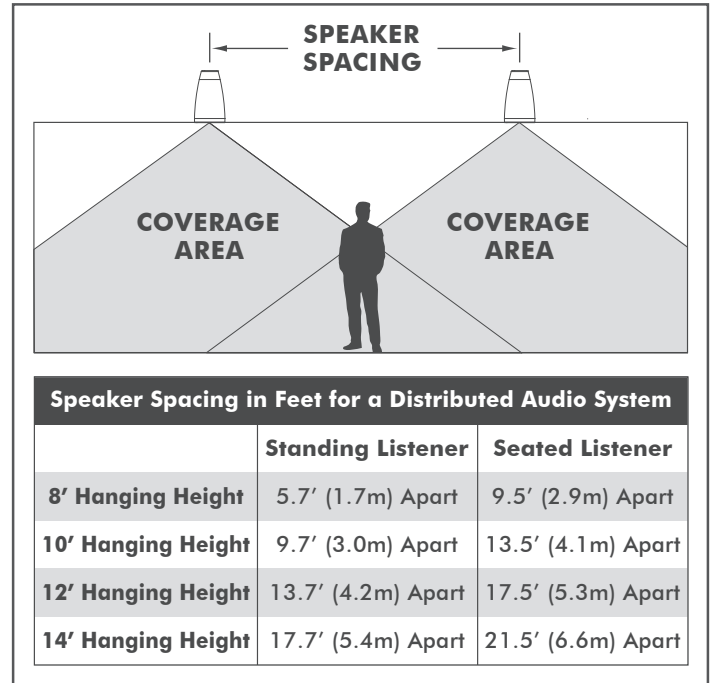

FIGURE 2: SPEAKER SPACING

## PAINTING THE GRILLES

1. Prime the grille with a metal primer/bonder in a spray can. Carefully follow the manufacturer's directions on the can.
2. We recommend using water-based latex paint on the grilles. Thin the paint with a proper thinning agent to a ratio of 1:1 paint-to-thinner, and strain it through a standard mesh strainer to remove any lumps.
3. Use a small touch-up gun or cap-spray gun with a #3 tip for painting.
  - a. Set the nozzle with a medium to wide fan
  - b. Set the pressure regulator to 60psi
  - c. Lightly spray the front of the grille in 3 quick strokes from approximately 10 inches away.
  - d. Let the paint set for a minute, then turn the grille 90° and lightly spray the grille again in 3 quick strokes. Repeat this step until all four sides of the grille have been evenly painted evenly.
4. While the paint is still wet, inspect the grille and make sure that excess paint has not collected underneath the grille frame, and that none of the grille perforations are filled with paint. If any are, use compressed air to blow the paint out of the perforations.

**IMPORTANT: IF YOU FIND ANY GRILLE PERFORATIONS THAT ARE PLUGGED WITH PAINT AFTER THE PAINT HAS DRIED, USE A STRAIGHT PIN OR SEWING NEEDLE TO CAREFULLY REMOVE THE PAINT.**

5. Once the paint has thoroughly dried, replace the scrim cloth on the back of the grille and mount the grille on the speaker.

## PAINTING THE SPEAKER SHELL

Sonance Professional Series Pendant speakers feature a tough polypropylene enclosure that can be painted. Sonance recommends using a weather-resistant outdoor paint and a spray gun.

1. If they have already been installed, remove the grilles from the speakers.
2. To protect the speaker driver units during painting, place the grilles on a piece of cardboard and trace around their outlines. Then cut the cardboard just inside of the trace line and fit these "paint plugs" into the speakers' baffles. (Be careful not to damage the driver components while fitting the paint plugs.)
3. Paint the speakers the desired color according to the paint manufacturer's instructions. Remove the paint plugs after the paint has thoroughly dried.

## CARRYING CAPACITY OF GRIPPLE FASTENERS

Sonance Professional Series Pendant speakers are supplied with Gripple hangers and suspension hardware that exceeds the required weight requirements. (See *figure 3*, as well as separate hanging hardware instruction sheet).

Gripple Fasteners Carrying Capacity		
MODEL	KGS	POUNDS
PS-P43T	3.01	6.64
PS-P63T	5.48	12.08
PS-P83T / PS-P83WT	8.50	18.74

FIGURE 3: GRIPPLE FASTENERS CARRYING CAPACITY

## INSTALLING THE SPEAKERS USING GRIPPLE SUSPENSION SYSTEMS

**CAUTION:** INSTALLATION MUST BE DONE BY QUALIFIED PERSONS USING SAFE RIGGING STANDARDS. USE EQUIPMENT ONLY IN ACCORDANCE WITH MANUFACTURER'S INSTRUCTIONS. DO NOT ALTER OR MODIFY. DO NOT USE EQUIPMENT IF THE EQUIPMENT IS NOT FUNCTIONING CORRECTLY OR IF THE EQUIPMENT IS DEFECTIVE.

1. Thread Gripple onto cable (see inset detail). Pass over ceiling anchor point (as shown) or through other secure anchor point of the building structure. Installer is responsible for ensuring that anchor point is secure to building structure. (See figure 4).

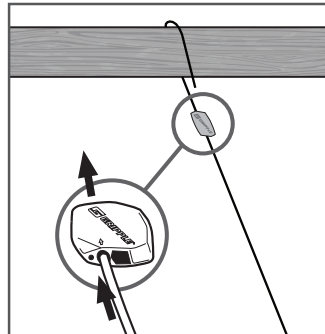

FIGURE 4: THREAD GRIPPLE

2. Thread cable through top cover of speaker. (See figure 5).

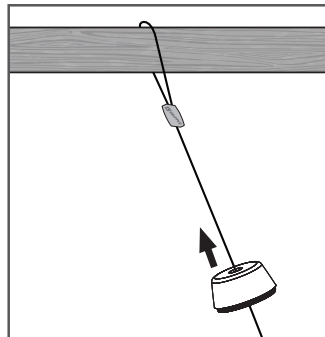

FIGURE 5: THREAD CABLE

3. Pass tail end of cable through the other channel of the Gripple. (See figure 6).

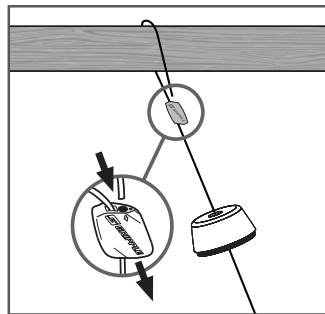

FIGURE 6: THREAD CABLE AGAIN

4. With speaker supported, snap main support hook hanger onto the center hole in the top bracket of the speaker. Adjust to proper height by pulling down on the cable through either end of Gripple. (See figure 7).

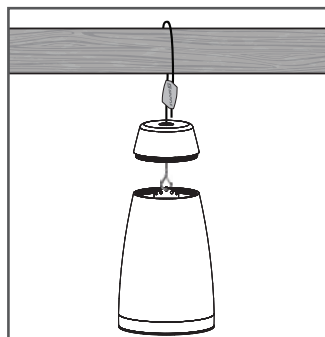

FIGURE 7: MAIN SUPPORT

5. Snap secondary support safety cable hook hanger onto one of the side holes in the top bracket of the speaker, and attach the top to a different ceiling support point of the building structure, per Steps 1 & 2. (See figure 8).

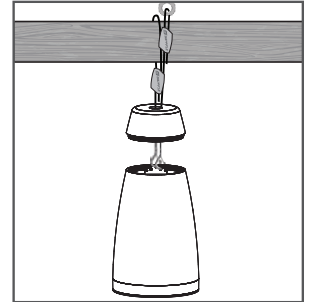

FIGURE 8: SECONDARY SUPPORT

6. After height adjustment is final, trim any unneeded extra cable tail wires with trimmer suitable for 2mm (0.077 in) diameter stranded aircraft-type cable. Screw back on top cover of speaker after speaker wire is connected. (See figure 9).

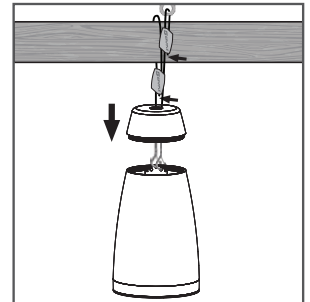

FIGURE 9: SCREW ON COVER

### HOW TO USE RELEASE KEY TO ADJUST HEIGHT OF SPEAKER

7. Make sure the weight of the load is supported. (See figure 10).
8. Insert key into small hole at bottom of Gripple. Push in 1/4" to release the cable. (See figure 11).
9. Adjust height. (See figure 12).
10. Remove key and re-secure the load. (See figure 13).

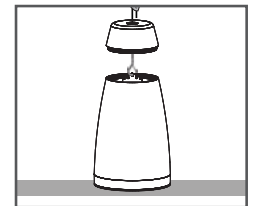

FIGURE 10: LOAD SUPPORTED

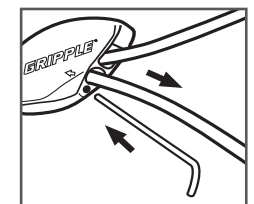

FIGURE 11: RELEASE CABLE

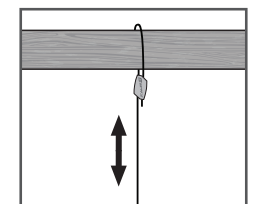

FIGURE 12: ADJUST HEIGHT

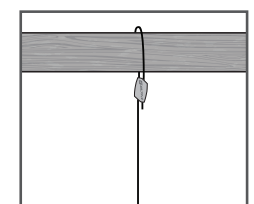

FIGURE 13: REMOVE KEY

# INSTALLING THE SPEAKERS USING GRIPPLE SUSPENSION SYSTEMS

11. Connect the wires from your amplifier to the Euroblock connector.  
(See figure 14).

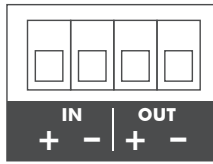

FIGURE 14: INPUT CONNECTOR

12. Feed speaker wire through the hole in the top of the Screw-On Top Cover.  
(See figure 15).

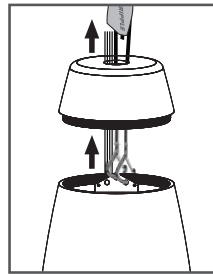
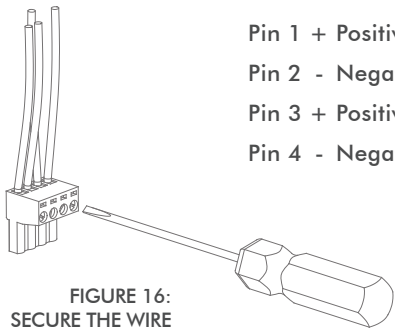

FIGURE 15: FEED SPEAKER WIRE

13. Strip approximately .1875" (5mm) of the insulation off each wire. Insert the wire into the correct square opening on the connector. Use a small flat head screwdriver to tighten the corresponding screw to secure the wire. (See figure 16).



- Pin 1 + Positive In
- Pin 2 - Negative In
- Pin 3 + Positive Out
- Pin 4 - Negative Out

FIGURE 16: SECURE THE WIRE

14. When using multiple speakers you can connect the speakers either in parallel or in the loop through method as shown below (see figure 17 & 18).

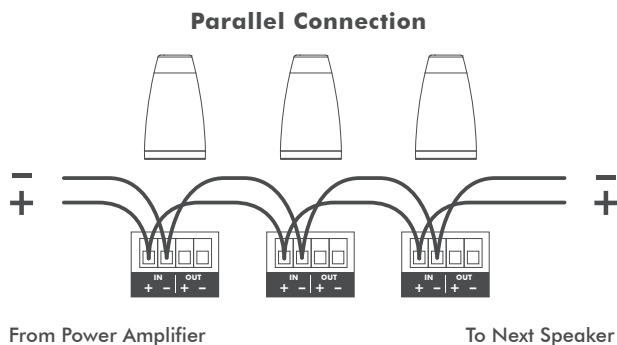

FIGURE 17: PARALLEL CONNECTION

## Loop Through Connection

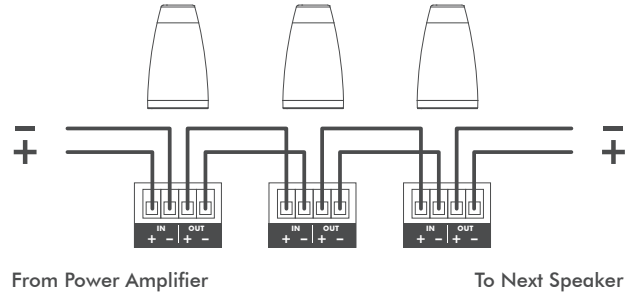

FIGURE 18: LOOP THROUGH CONNECTION

15. Screw the top cover onto the speaker  
(see figure 19).

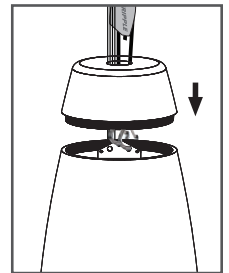

FIGURE 19: SCREW ON COVER

16. Determine the proper wattage setting for each speaker in the installation and set each speaker's transformer tap selector on the front of the speaker accordingly (see figure 20).

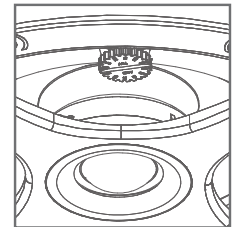

FIGURE 20: TRANSFORMER TAP SELECTION

17. Fit the grilles onto the speaker.  
(See figure 21).

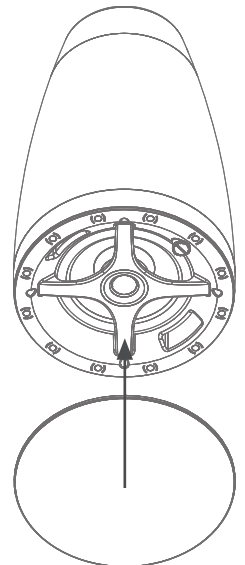

FIGURE 21: GRILLE INSTALLATION



## PS-P43T TECHNICAL SPECIFICATIONS

### LOUDSPEAKER

<b>Frequency Range (-10dB):</b>	57Hz – 25kHz
<b>Frequency Range (-3dB):</b>	75Hz – 20kHz
<b>Power Capacity:</b>	60 Watts Continuous Program Power 30 Watts Continuous Pink Noise
<b>Nominal Sensitivity:</b>	87dB
<b>Nominal Coverage Angle:</b>	120 degrees conical coverage
<b>Directivity Factor (Q):</b>	7.6
<b>Directivity (DI):</b>	8.1dB
<b>Rated Maximum SPL:</b>	105dB @ 1 meter (3.3 feet) average, 110dB peak
<b>Rated Impedance:</b>	8 ohms nominal, 6 ohms minimum
<b>Transformer Taps:</b>	70V: 30W, 15W, 7.5W and 3.8W 100V: 30W, 15W and 7.5W
<b>Crossover Point:</b>	3000Hz
<b>Overall Dimension:</b>	6.3" Diameter x 11" Depth (160mm x 280mm)
<b>Net Weight:</b>	6.45 lbs (2.93kg) each
<b>Shipping Weight:</b>	18.92 lbs (8.58kg) pair
<b>Unit of Measure:</b>	Pair
<b>Color:</b>	Black or White
<b>Grille:</b>	Bezel-less magnetically retained grille

### TRANSDUCERS

<b>LF Driver:</b>	4" (100mm) Polypropylene Cone, Butyl Rubber Surround
<b>HF Driver:</b>	1" (25mm) Cloth Dome, Pivoting, Ferrofluid cooled

### ENCLOSURE

<b>Input Connectors:</b>	Four pin, Euroblock with loop output connections
<b>Safety Agency:</b>	UL 1480, UL 2239, NFPA 70
<b>Suspension Points:</b>	5 Points, top mounted

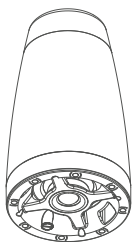

### Included Accessories

- Euroblock Connector x 2
- 16.4' (5m) Stainless Steel Cable with Snap Hook x 4
- Gripper® Hanger x 4
- Gripper® Adjustment Tool x 2
- Weather Boot x 2
- Grille x 2

### Optional Accessories

- Replacement Round Grille White (pair) | 40152
- Replacement Round Grille Black (pair) | 40155
- Replacement Hanging Hardware Kit | 40176

## PS-P63T TECHNICAL SPECIFICATIONS

### LOUDSPEAKER

<b>Frequency Range (-10dB):</b>	49Hz – 25kHz
<b>Frequency Range (-3dB):</b>	65Hz – 20kHz
<b>Power Capacity:</b>	120 Watts Continuous Program Power 60 Watts Continuous Pink Noise
<b>Nominal Sensitivity:</b>	88dB
<b>Nominal Coverage Angle:</b>	120 degrees conical coverage
<b>Directivity Factor (Q):</b>	6.5
<b>Directivity (DI):</b>	7.9dB
<b>Rated Maximum SPL:</b>	108dB @ 1 meter (3.3 feet) average, 116dB peak
<b>Rated Impedance:</b>	8 ohms nominal, 6 ohms minimum
<b>Transformer Taps:</b>	70V: 60W, 30W, 15W and 7.5W 100V: 60W, 30W and 15W
<b>Crossover Point:</b>	2750Hz
<b>Overall Dimension:</b>	9.13" Diameter x 15.6" Depth (232mm x 396mm)
<b>Net Weight:</b>	11.63 lbs (5.28kg) each
<b>Shipping Weight:</b>	33.38 lbs (15.14kg) pair
<b>Unit of Measure:</b>	Pair
<b>Color:</b>	Black or White
<b>Grille:</b>	Bezel-less magnetically retained grille

### TRANSDUCERS

<b>LF Driver:</b>	6.5" (165mm) Polypropylene Cone, Butyl Rubber Surround
<b>HF Driver:</b>	1" (25mm) Cloth dome, Pivoting, Ferrofluid cooled

### ENCLOSURE

<b>Input Connectors:</b>	Four pin, Euroblock with loop output connections
<b>Safety Agency:</b>	UL 1480, UL 2239, NFPA 70
<b>Suspension Points:</b>	5 Points, top mounted

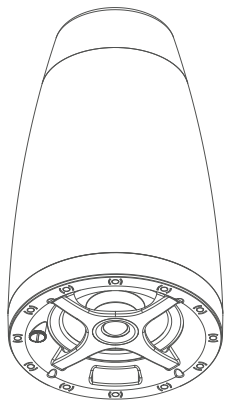

### Included Accessories

- Euroblock Connector x 2
- 16.4' (5m) Stainless Steel Cable with Snap Hook x 4
- Gripple® Hanger x 4
- Gripple® Adjustment Tool x 2
- Weather Boot x 2
- Grille x 2

### Optional Accessories

- Replacement Round Grille White (pair) | 40153
- Replacement Round Grille Black (pair) | 40156
- Replacement Hanging Hardware Kit | 40176

## PS-P83T TECHNICAL SPECIFICATIONS

### LOUDSPEAKER

<b>Frequency Range (-10dB):</b>	41Hz – 25kHz
<b>Frequency Range (-3dB):</b>	55Hz – 20kHz
<b>Power Capacity:</b>	160 Watts Continuous Program Power 80 Watts Continuous Pink Noise
<b>Nominal Sensitivity:</b>	90dB
<b>Nominal Coverage Angle:</b>	120 degrees conical coverage
<b>Directivity Factor (Q):</b>	7.6
<b>Directivity (DI):</b>	8.1dB
<b>Rated Maximum SPL:</b>	110dB @ 1 meter (3.3 feet) average, 116dB peak
<b>Rated Impedance:</b>	8 ohms nominal, 6 ohms minimum
<b>Transformer Taps:</b>	70V: 60W, 30W, 15W and 7.5W 100V: 60W, 30W and 15W
<b>Crossover Point:</b>	2750Hz
<b>Overall Dimension:</b>	11.06" Diameter x 19.7" Depth (281mm x 500mm)
<b>Net Weight:</b>	16.26 lbs (7.38kg) each
<b>Shipping Weight:</b>	46.97 lbs (21.31kg) pair
<b>Unit of Measure:</b>	Pair
<b>Color:</b>	Black or White
<b>Grille:</b>	Bezel-less magnetically retained grille

### TRANSDUCERS

<b>LF Driver:</b>	8" (203mm) Polypropylene Cone, Butyl Rubber Surround
<b>HF Driver:</b>	1" (25mm) Cloth Dome, Pivoting, Ferrofluid cooled

### ENCLOSURE

<b>Input Connectors:</b>	Four pin, Euroblock with loop output connections
<b>Safety Agency:</b>	UL 1480, UL 2239, NFPA 70
<b>Suspension Points:</b>	5 Points, top mounted

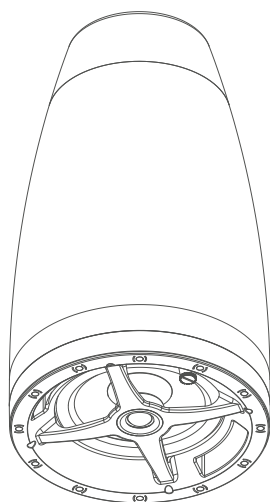

### Included Accessories

- Euroblock Connector x 2
- 16.4' (5m) Stainless Steel Cable with Snap Hook x 4
- Gripple® Hanger x 4
- Gripple® Adjustment Tool x 2
- Weather Boot x 2
- Grille x 2

### Optional Accessories

- Replacement Round Grille White (pair) | 40154
- Replacement Round Grille Black (pair) | 40157
- Replacement Hanging Hardware Kit | 40176

## PS-P83WT TECHNICAL SPECIFICATIONS

### LOUDSPEAKER

<b>Frequency Range (-10dB):</b>	32Hz – 300Hz
<b>Frequency Range (-3dB):</b>	50Hz – 150Hz
<b>Power Capacity:</b>	200 Watts Continuous Program Power 125 Watts Continuous Pink Noise
<b>Nominal Sensitivity:</b>	89dB
<b>Nominal Coverage Angle:</b>	180 degrees conical coverage
<b>Directivity Factor (Q):</b>	N/A
<b>Directivity (DI):</b>	N/A
<b>Rated Maximum SPL:</b>	110dB @ 1 meter (3.3 feet) average, 116dB peak
<b>Rated Impedance:</b>	8 ohms nominal, 6 ohms minimum
<b>Transformer Taps:</b>	70V: 120W, 60W, 30W and 15W 100V: 120W, 60W and 30W
<b>Crossover Point:</b>	150Hz
<b>Overall Dimension:</b>	11.06" Diameter x 19.7" Depth (281mm x 500mm)
<b>Net Weight:</b>	17.71 lbs (8.03kg) each
<b>Shipping Weight:</b>	22.97 lbs (10.42kg) each
<b>Unit of Measure:</b>	Pair
<b>Color:</b>	Black or White
<b>Grille:</b>	Bezel-less magnetically retained grille

### TRANSDUCERS

<b>LF Driver:</b>	8" (203mm) Polypropylene Cone, Butyl Rubber Surround
<b>HF Driver:</b>	N/A

### ENCLOSURE

<b>Input Connectors:</b>	Four pin, Euroblock with loop output connections
<b>Safety Agency:</b>	UL 1480, UL 2239, NFPA 70
<b>Suspension Points:</b>	5 Points, top mounted

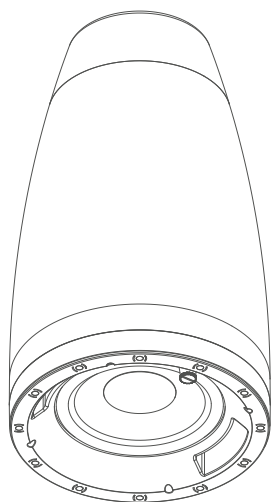

### Included Accessories

- Euroblock Connector x 1
- 16.4' (5m) Stainless Steel Cable with Snap Hook x 2
- Gripple® Hanger x 2
- Gripple® Adjustment Tool x 1
- Weather Boot x 1
- Grille x 1

### Optional Accessories

- Replacement Round Grille White (pair) | 40154
- Replacement Round Grille Black (pair) | 40157
- Replacement Hanging Hardware Kit | 40176

## CERTIFICATIONS

### SAFETY AGENCY COMPLIANCE

Sonance Professional Series Pendant loudspeakers models PS-P43T, PS-P63T, PS-P83T & PS-P83WT meet the following standards:

**UL 1480:** Listed Standard For Safety For Speakers for Fire Alarm, Emergency, and Commercial and Professional Use.

**UL 2239:** Standard For Safety Hardware for the Support of Conduit, Tubing, and Cable

**NFPA 70:** 2002 National Electrical Code



## TECHNICAL ASSISTANCE AND SERVICE

The Technical Assistance Department at Sonance is available at (949) 492-7777 to answer any questions concerning the operation and installation of your speakers between the hours of 7:00 AM and 5:00 PM Pacific time, Monday through Friday, except holidays.

In the event your unit should need repair or service, you may return the unit to your authorized dealer or use the following guidelines:

**PLEASE KEEP ORIGINAL PACKAGING WHEN POSSIBLE.**

1. Be prepared to state the model number and / or serial number, date of purchase, and dealer's name and address when calling.
2. Contact Sonance directly at (949) 492-7777 or at [www.sonance.com](http://www.sonance.com)  
**YOU MUST HAVE PRIOR AUTHORIZATION TO RETURN YOUR UNIT.**
3. If you are returning the product directly to Sonance, call us to obtain a return authorization number before shipping.
4. Ship the product via United Parcel Service, Federal Express, or other package delivery service. Please do not use the U.S. Postal Service.
5. Write the return authorization number on the outside of the box.
6. Ship to:

Attn: Quality Assurance Department  
 Sonance  
 991 Calle Amanecer  
 San Clemente, CA 92673

## WARRANTY, REMEDY, EXCLUSIONS AND LIMITATIONS (U.S. ONLY)

### Limited Warranty

Sonance warrants this product to the original purchaser to be free from defects in material and workmanship, under normal use and conditions, for a period of five (5) years from the date of original purchase as shown on the invoice. Sonance will at its option and expense during the warranty period, either repair the defect or replace the Product with a new or remanufactured Product or a reasonable equivalent.

The foregoing exclusive warranty gives you specific legal rights, and you may have other rights, which vary from state to state. This warranty applies exclusively to the original purchaser.

The exclusive warranty does not apply and is ineffective if:

1. The invoice fails to establish that the product was purchased from an authorized Sonance dealer or distributor;
2. The product was subjected to misuse, neglect, accident, or improper installation.  
[Damage to the product was caused by accident, abuse, or misuse];
3. The product was modified, altered, or repaired by unauthorized personnel; or
4. The unit was not used as described in the installation and operating instructions.

### Exclusive Remedy

Sonance agrees, at its option during the five (5) year warranty period, to repair any defect in material or workmanship or to furnish an equal product in exchange without charge to the purchaser, subject to verification of the defect and proof of the date of purchase.

### Exclusions

TO THE EXTENT PERMITTED BY LAW, THE WARRANTY SET FORTH ABOVE IS IN LIEU OF, AND EXCLUSIVE OF, ALL OTHER WARRANTIES, EXPRESS OR IMPLIED, AND IS THE SOLE AND EXCLUSIVE WARRANTY PROVIDED BY SONANCE. ALL OTHER EXPRESS AND IMPLIED WARRANTIES, INCLUDING THE IMPLIED WARRANTIES OF MERCHANTABILITY, IMPLIED WARRANTY OF FITNESS FOR USE, AND IMPLIED WARRANTY OF FITNESS FOR A PARTICULAR PURPOSE ARE SPECIFICALLY EXCLUDED.

No one is authorized to make or modify any warranties on behalf of Sonance. The warranty stated above is the sole and exclusive remedy and Sonance's performance shall constitute full and final satisfaction of all obligations, liabilities and claims with respect to the Product.

IN ANY EVENT, SONANCE SHALL NOT BE LIABLE FOR CONSEQUENTIAL, INCIDENTAL, ECONOMIC, PROPERTY, BODILY INJURY, OR PERSONAL INJURY DAMAGES ARISING FROM THE PRODUCT, ANY BREACH OF THIS WARRANTY OR OTHERWISE.

This warranty statement gives you specific legal rights, and you may have other rights which vary from state to state. Some states do not allow the exclusion of implied warranties or limitations of remedies, so the above exclusions and limitations may not apply. If your state does not allow disclaimer of implied warranties, the duration of such implied warranties is limited to period of Sonance's express warranty.

### Warranty Exclusions and Damage Limitations

**Additional Limitations and Exclusions from Warranty Coverage:** The warranty described above is non-transferable, applies only to the initial installation of the Product, does not include installation of any repaired or replaced Product, does not include damage to allied or associated equipment which may result for any reason from use with this Product, and does not include labor or parts caused by accident, disaster, negligence, improper installation, misuse (e.g. overdriving the amplifier or speaker, excessive heat or cold or humidity, outdoor installation), or from service or repair which has not been authorized by Sonance.

**Obtaining Authorized Service:** To qualify for the warranty, you must contact your authorized Sonance Dealer/Installer or call Sonance Customer Service at (949) 492-7777 within the warranty period, must obtain a return merchandise number (RMA), and must deliver the Product to Sonance shipping prepaid during the warranty period, together with the original sales receipt, or invoice or other satisfactory proof of purchase.



SONANCE®

©2017 Sonance. All rights reserved. Sonance is a registered trademarks of Dana Innovations.

Due to continuous product improvement, all features and specifications are subject to change without notice.

For the latest Sonance product specification information visit our website: [www.sonance.com](http://www.sonance.com)

SONANCE • 991 Calle Amanecer • San Clemente, CA 92673 USA

(949) 492-7777 • FAX: (949) 361-5151

[www.sonance.com/professionalseries](http://www.sonance.com/professionalseries)