

# **TG 1000**

**DIGITAL WIRELESS SYSTEM**

OPERATING INSTRUCTIONS

1.	Safety Instructions . . . . .	Page	3
1.1	TG 1000 Receiver . . . . .	Page	3
1.2	TG 1000 Handheld and Beltpack Transmitters . . . . .	Page	4
1.3	NiMH Rechargeable Batteries, Alkaline Batteries. . . . .	Page	4
1.4	Disposal. . . . .	Page	4
2.	Digital TG 1000 UHF Diversity Receiver . . . . .	Page	5
2.1	Controls and Indicators . . . . .	Page	5
2.2	How to Lock the Buttons of the Receiver . . . . .	Page	5
2.3	How to Connect the Antennae . . . . .	Page	6
2.4	How to Connect and Install Remote Antennae. . . . .	Page	6
2.5	Mounting and Connection. . . . .	Page	7
2.5.1	Where to Place the Receiver . . . . .	Page	7
2.5.2	Rack Mounting. . . . .	Page	7
2.5.3	How to Connect the Receiver to a Microphone Input . . . . .	Page	7
2.5.4	How to Connect the Receiver to the Mains / Disconnect from the Mains . . . . .	Page	7
2.6	Setting up . . . . .	Page	8
2.6.1	How to Operate the Receiver . . . . .	Page	8
2.7	Menu Settings . . . . .	Page	9
2.8	Function Settings . . . . .	Page	17
2.8.1	How to Connect a Receiver to a Network . . . . .	Page	17
2.8.2	Dante™ Audio Network . . . . .	Page	20
2.8.3	How to Set the Brightness of the Display . . . . .	Page	21
2.8.4	Settings for the Receiver Display . . . . .	Page	21
2.8.5	Factory Reset . . . . .	Page	22
2.8.6	How to Display the Version and Region Code . . . . .	Page	22
2.8.7	How to Update the Firmware of the Receiver . . . . .	Page	23
2.8.8	How to Update the Firmware of the Transmitter . . . . .	Page	23
2.9	Monitoring . . . . .	Page	24
2.10	Synchronisation . . . . .	Page	25
2.11	Multi-Channel Operation (Cascading Several TG 1000 Receivers) . . . . .	Page	25
3.	Chameleon Software. . . . .	Page	26
4.	WA-AS 6 Antenna Splitter . . . . .	Page	30
4.1	Controls and Indicators . . . . .	Page	30
4.2	General Information . . . . .	Page	30
4.3	Mounting and Installation . . . . .	Page	31
5.	Digital TG 1000 UHF Handheld Transmitter . . . . .	Page	32
5.1	Controls and Indicators . . . . .	Page	32
5.2	How to Attach the Microphone Head . . . . .	Page	33
5.3	How to Insert the Batteries . . . . .	Page	35
5.4	How to Operate the Handheld Transmitter. . . . .	Page	36
5.5	Synchronisation / How to Transmit the Receiving Frequency to the Transmitter. . . . .	Page	36
5.6	Maintenance . . . . .	Page	37
6.	Digital TG 1000 UHF Beltpack Transmitter . . . . .	Page	38
6.1	Controls and Indicators . . . . .	Page	38
6.2	How to Insert the Batteries . . . . .	Page	39
6.3	How to Operate the Beltpack Transmitter. . . . .	Page	39
6.4	Synchronisation / How to Transmit the Receiving Frequency to the Transmitter. . . . .	Page	40
6.5	How to Use the Gain Switch . . . . .	Page	40
6.6	How to Mount the Belt Clip. . . . .	Page	40
7.	General Instructions for all Transmitters . . . . .	Page	41
8.	Comments on the Audio Level . . . . .	Page	41
9.	Components . . . . .	Page	43
10.	Accessories . . . . .	Page	43
11.	Technical Specifications . . . . .	Page	44
12.	Service . . . . .	Page	46
13.	Licensing . . . . .	Page	46
14.	Simplified EU declaration of conformity . . . . .	Page	46
	FCC Regulation . . . . .	Page	47

Thank you for selecting the TG 1000 wireless system from beyerdynamic. Please take some time to read carefully through this manual before setting up the equipment.

Due to the high switching bandwidth of 319 MHz (470 - 789 MHz) the TG 1000 can be used worldwide and represents a long-term investment. The system is extremely flexible and can be used for professional audio applications, touring or for installations.

As a real digital wireless system the TG 1000 operates with a 24 bit frequency shift keying. Both the transmitter and receiver communicate digitally in the UHF range which ensures high reliability and exceptional audio quality.

A digital encryption prevents unauthorised listening. The “Triple Play” CODEC is the heart of the TG 1000 system. CODEC is an internal software to encode and decode a digital data signal. Instead of a standard CODEC a proprietary solution has been found for the TG 1000 system, the so-called “Triple Play” CODEC, which has a low latency of 1.2 ms (important when using multiple digital devices) and is characterised by a high fault resistance, which ensures an improved RF coverage and excellent audio quality.

The unique “Genuine Guitar” technology of the TG 1000 provides a clear guitar sound. Since low frequencies can be processed up to 20 Hz, the TG 1000 is ideal for bass guitars.

The range is more than 300 meters and a dynamic range of 128 dB provides an excellent signal-to-noise ratio.

Due to the embedded Web server the “Chameleon” software communicates with all devices such as PC, laptop, tablet, smartphone, etc. and is compatible with all operating systems based on Windows, Mac, Linux, iOS, Android, etc..

The receivers can be cascaded so that multi-channel systems can be realised with up to 12 channels and no additional antenna splitters.

Ergonomic handheld and backpack transmitters complete the system. Sophisticated battery solutions provide a quick battery change.

The TG 1000 system consist of the following components:

- Digital two-channel UHF diversity receiver
- Digital handheld transmitter
- Digital backpack transmitter

## 1. Safety Instructions

### General

- READ these instructions.
- KEEP these instructions.
- HEED all warnings.

### Exemption from liability

- beyerdynamic GmbH & Co. KG will not be liable if any damage, injury or accident occurs due to negligent, incorrect or inappropriate operation of the product.

### 1.1 TG 1000 Receiver



The lightning flash within an equilateral triangle is intended to alert the user to the presence of uninsulated dangerous voltage within the device that may be sufficient enough to constitute a risk of electric shock to users.



The exclamation mark within an equilateral triangle is intended to alert the user to the presence of important operating and maintenance instructions in the literature accompanying the product.

1. Read these instructions.
2. Keep these instructions.
3. Heed all warnings.
4. Follow all instructions.
5. Do not use this apparatus near water.
6. Clean only with dry cloth.
7. Do not block any ventilation openings. Install in accordance with the manufacturer's instructions.
8. Do not install near any heat sources such as radiators, heat registers, stoves, or other apparatus (including amplifiers) that produce heat.
9. Do not defeat the safety purpose of the polarized or grounding-type plug. A polarized plug has two blades with one wider than the other. A grounding type plug has two blades and a third grounding prong. The wide blade or the third prong are provided for your safety. If the provided plug does not fit into your outlet, consult an electrician for replacement of the obsolete outlet.
10. Protect the power cord from being walked on or pinched particularly at plugs, convenience receptacles, and the point where they exit from the apparatus.
11. Only use attachments/accessories specified by the manufacturer.
12. Use only with the cart, stand, tripod, bracket, or table specified by the manufacturer, or sold with the apparatus. When a cart is used, use caution when moving the cart/apparatus combination to avoid injury from tip-over.
13. Unplug this apparatus during lightning storms or when unused for long periods of time.
14. Refer all servicing to qualified service personnel. Servicing is required when the apparatus has been damaged in any way, such as power supply cord or plug is damaged, liquid has been spilled or objects have fallen into the apparatus, the apparatus has been exposed to rain or moisture, does not operate normally, or has been dropped.

### Location

- The equipment must be set up so that the mains switch, mains plug and all connections on the rear of the device are easily accessible.
- If you transport the equipment to another location take care to ensure that it is adequately secured and can never be damaged by being dropped or by impacts on the equipment.

### Fire hazard

- Never place naked flames (e.g. candles) near the equipment.

### Humidity / heat sources

- Never expose the equipment to rain or a high level of humidity. For this reason do not install it in the immediate vicinity of swimming pools, showers, damp basement rooms or other areas with unusually high atmospheric humidity.
- Never place objects containing liquid (e.g. vases or drinking glasses) on the equipment. Liquids in the equipment could cause a short circuit.
- Do not install near any heat sources such as radiators, heat registers, stoves or other apparatus (including amplifiers) that produce heat.

### Connection

- The equipment must be connected to a mains socket that has an earth contact.
- Protect the power cord from being walked on or pinched particularly at plugs, convenience receptacles, and the point where they exit from the apparatus.
- Lay all connection cables so that they do not present a trip hazard.
- Whenever working on the inputs and outputs of the equipment switch off power.
- Check whether the connection figures comply with the existing mains supply. Serious damage could occur due to connecting the system to the wrong power supply. An incorrect mains voltage could damage the equipment or cause an electric shock.
- Please note that different operating voltages require the use of different types of power cable and plugs.

Please refer to the following table:

Voltage	Power plug according to standard
110 - 125 V	UL817 and CSA C 22.2 no 42.
220 - 230 V	CEE 7 page VII, SR section 107-2-D1/IEC 83 page C4.
240 V	BS 1363 (1984): "Specification for 13A fused plugs and switched and un-switched socket outlets."

- If the equipment causes a blown fuse or a short circuit, disconnect it from the mains and have it checked and repaired.
- Do not hold the mains cable with wet hands. There must be no water or dust on the contact pins. In both cases you could receive an electric shock.
- The mains cable must be firmly connected. If it is loose there is a fire hazard.
- Always pull out the mains cable from the mains and/or from the equipment by the plug – never by the cable. The cable could be damaged and cause an electric shock or fire.
- Do not use the equipment if the mains plug is damaged.
- If you connect defective or unsuitable accessories, the equipment could be damaged. Only use connection cables available from or recommended by beyerdynamic. If you use cables you have made up yourself, all claim to warranty is null and void.
- In order to disconnect the receiver from AC power, switch it off and disconnect the power plug from the power socket.

#### Maintenance

- Only clean the equipment with a slightly damp or dry cloth. Never use solvents as these damage the surface.

#### Troube shooting and servicing

- Do not open the equipment without authorisation. You could receive an electric shock. There are no user-serviceable parts inside.
- Leave all service work to authorised expert personnel.

## 1.2 TG 1000 Handheld and Beltpack Transmitters

- Protect the transmitter from moisture and sudden impacts. You could either injure yourself or others or damage the transmitter.
- Always switch off the transmitter before changing the battery.

#### Handheld Transmitter

- Do not blow into the microphone. In a condenser microphone this could damage the transformer. It is preferable to carry out a speech trial.

#### Beltpack Transmitter

- Clip-on microphones are often very compact. If they are accidentally swallowed there is a risk of choking. Always keep this type of microphone away from small children.

#### Charging contacts

- Avoid letting the rechargeable batteries become too discharged. The rechargeable batteries could be damaged and the life of them could be reduced.
- If battery operated equipment is not used for a lengthy period (e.g. 1 year) the self-discharge of the battery could be accelerated. The temperature for long-term storage should be between +10° C and +30° C.
- If the handheld transmitter is not used for several months, the rechargeable batteries in the transmitter should be charged up at least twice a year in order to avoid them running out and deterioration in the performance due to self discharge.
- From time to time the battery and charging contacts of the transmitter should be cleaned with a lint-free soft cloth moistened with spirits or alcohol. Please remove the batteries from the battery compartment before cleaning.

- The charging contacts of the transmitter can cause damage to property, injuries or fire damage if they come into contact with conductive material such as jewellery, keys or chains. This closes the circuit and can thus cause the material to heat up. To avoid this sort of unwanted circuit, the charging contacts must be handled with caution. This applies particularly if the handheld transmitter is transported in a bag or some other container together with metal objects.

## 1.3 NiMH Rechargeable Batteries, Alkaline Batteries

- The handheld and beltpack transmitters of the TG 1000 system can only be powered with AA (LR6) Mignon alkaline batteries or equivalent NiMH rechargeable batteries.
- The normal commercial alkaline batteries can have a length tolerance of 2 - 3 mm. When changing the battery always ensure good contact.
- If the transmitter is not being used for weeks or months, please remove the batteries. Batteries can leak when not being used for a long time and corrode the conductor strips and components. Repair is not then possible. In this case all warranty claims are null and void. The description "leak proof" on batteries is no guarantee that they will not run out.
- Never take batteries apart yourself. The battery acid contained will damage skin and clothing.
- If abused or misused, rechargeable batteries may leak. In extreme cases, they may even present an explosion, heat, fire, smoke or gas hazard.
- Never expose batteries to excessive heat such as sunshine, fire or the like.

## 1.4 Disposal

- If you throw away the transmitter, please remove the batteries.
- Old batteries may contain substances that are harmful to your health and environment.
- Dispose used batteries always according to the applicable disposal regulations. Please do not throw used battery packs into the fire (danger of explosion) or your household rubbish, take them to your local collection points. The return is free and required by law. Please dispose discharged batteries only.
- For removing the batteries, please refer to chapter "How to insert/replace the batteries".
- All batteries are recycled to reclaim valuable material such as iron, zinc or nickel.
- This symbol on the product, in the instructions or on the packaging means that your electrical and electronic equipment should be disposed at the end of its life separately from your household waste. There are separate collection systems for recycling in the EU. For more information, please contact the local authority or your retailer where you purchased the product.



## 2. Digital TG 1000 UHF Diversity Receiver

### 2.1 Controls and Indicators

#### Front View

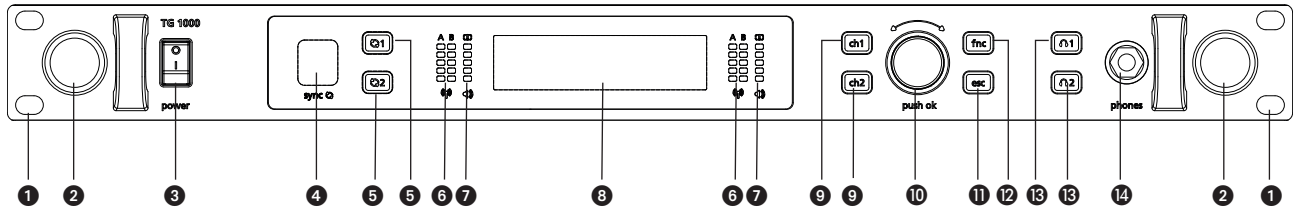

- |   |  |
|---|--|
| <ul style="list-style-type: none"> <li>❶ Hole for 19" rack mounting</li> <li>❷ Hole for mounting the antennae on the front</li> <li>❸ On-off switch</li> <li>❹ Infrared interface for synchronising receiver and transmitter</li> <li>❺ Button of synchronisation for channel 1 or channel 2</li> <li>❻ RF indicators channel 1 or channel 2</li> <li>❼ AF indicators with peak indicator channel 1 or channel 2</li> </ul> | <ul style="list-style-type: none"> <li>❽ Display channel 1 and channel 2</li> <li>❾ Channel selector button 1 or 2</li> <li>❿ Rotary switch for selection and settings</li> <li>⓫ ESC button (Escape)</li> <li>⓬ Function button</li> <li>⓭ Button to monitor channel 1 or channel 2 via headphones</li> <li>⓮ Headphone connection, 1/4" stereo jack (6.35 mm)</li> </ul> |
|---|--|

#### Rear View

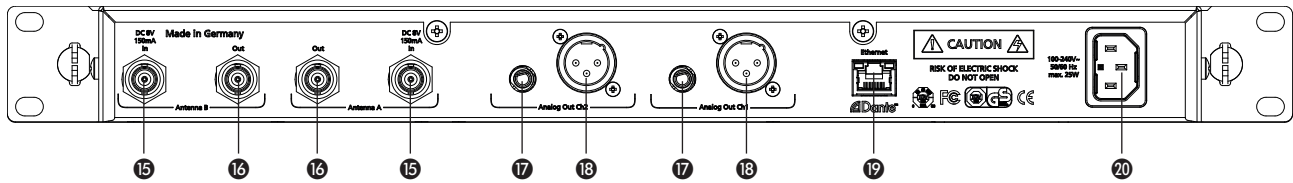

- |  |  |
|--|--|
| <ul style="list-style-type: none"> <li>❷ Antenna input A or B, BNC socket, 8 V DC, 150 mA</li> <li>❸ Antenna output A or B, BNC socket</li> <li>❹ Audio output, balanced, 3 pole jack, channel 1 or channel 2</li> </ul> | <ul style="list-style-type: none"> <li>❺ Audio output, balanced, 3-pin XLR, channel 1 or channel 2</li> <li>❻ Ethernet and Dante network interface (RJ45)</li> <li>❼ Mains connection</li> </ul> |
|--|--|

### 2.2 How to Lock the Buttons of the Receiver

- With this function you can lock the buttons of the receiver to prevent any settings from being changed.

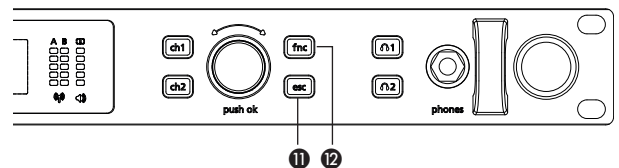

- Switch on the receiver. Press the ESC button ❾ and the Function button ⓬ until the message "Front panel locked." is displayed.
- The locked state is maintained even when the receiver is turned off and on again.

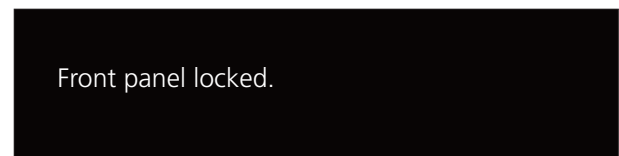

Lock the buttons

- In order to unlock the buttons, press the ESC button ❾ and Function button ⓬ until the message "Front panel unlocked." is displayed.

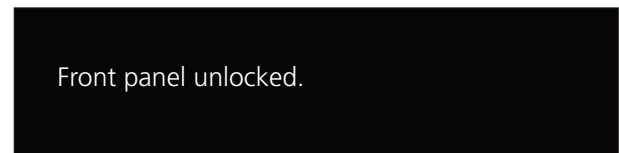

Unlock the buttons

## 2.3 How to Connect the Antennae

- Connect the supplied antennae to the A and B antenna inputs 15 and set them at an angle (approx. 60°) in the shape of a “V”.  
**Important:** For the diversity operation it is absolutely necessary to connect both antennae! A weighting circuit ensures that an antenna is selected that supplies the better signal.
- As an alternative, you can mount the antennae on the front of the receiver. Please use the WA-CKF antenna front mounting kit.
- Connect the antenna cable of the antenna front mounting kit to the A and B antenna inputs 15.
- Remove the protective caps from the holes for mounting the antennae on the front 2.
- Remove the nuts and washers of the supplied adapters.
- Slide the adapters through the appropriate hole 2 with the thread of the adapter showing to the front.
- Tighten the adapters with the washers and the nuts.
- If required, mount the receiver into a 19" rack.
- Connect the antenna cables to the rear of the adapter.
- Connect the antennae to the front (BNC sockets) of the adapter.
- Set the antennae at an angle in the shape of a “V”.

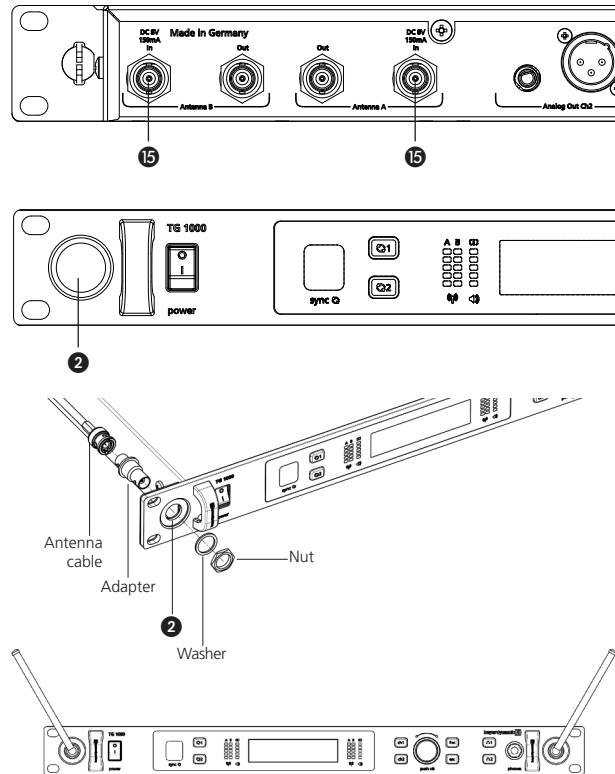

## 2.4 How to Connect and Install Remote Antennae

If the reception is not good, we recommend using remote antennae. We recommend the passive WA-ATDA directional antenna (optional available). In order to power active antennae, the receiver provides a short-circuit-proof voltage of 8 V DC at both antenna inputs with a maximum load of 150 mA.

1. Connect the receiving antennae to the corresponding antenna inputs 15 and place the antennae to the right and left of the receiver in the operating range where the transmitter is to be used. If necessary change the position of the antennae to improve diversity reception.
2. The distance between the two receiving antennae should be at least 1 m.
3. The distance between transmitting and receiving antennae should be at least 3 m to avoid overloading and interference between different channels. We therefore recommend installing the antennae in a high position, especially in multi-channel systems.
4. If the operating range of the transmitters is greater than the stage, the antennae can be mounted vertically on the ceiling. The distance between the two receiving antennae should be approximately half the total operating range.

### Important:

1. Install the receiving antennae in the same area as the transmitter.
2. To avoid interference do not install the antennae near digitally controlled components.
3. Keep a minimum distance of 0.5 m from metallic objects, including reinforced concrete walls or pillars.
4. Do not bend the antenna cables at the antenna input, and ensure that they are not subjected to undue stress.

## 2.5 Mounting and Connection

### 2.5.1 Where to Place the Receiver

- Place the receiver in the same room where the transmission takes place.
- Place the receiver as close as possible to the transmitter. For optimal reception, a free line of sight is advisable between transmitter and receiver.
- Do not place the receiver near digitally controlled devices.

### 2.5.2 Rack Mounting

- The receiver is provided with holes ❶ on the left and right hand side for 19" rack mounting.
- Insert the receiver into the 19" rack and tighten it with four screws (not included in the delivery).

#### Warning!

- When installing the receiver into a 19" rack or with other devices into a rack, the ambient temperature, the mechanical stress and the electrical potentials will be different than for devices that are available separately.
- If you install more than one receiver into a rack, you should leave one height unit free or you should make sure that there is an appropriate ventilation (e.g. through ventilation panels), because of the heat between the receivers.
- The ambient temperature of the rack must not exceed the temperature specified in the technical specifications.
- Make sure that the rack is not top-heavy with too many devices and will overturn.
- When connecting to the power supply read the information on the typeplate. Avoid overloading circuits. If necessary, provide an overcurrent protection.

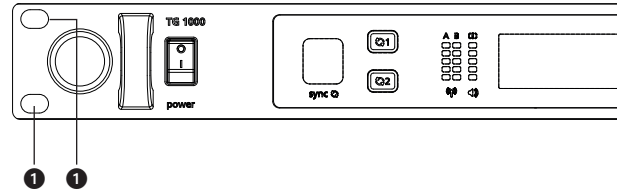

### 2.5.3 How to Connect the Receiver to a Microphone Input

- The receiver is provided with balanced audio outputs.
- Connect the balanced XLR ❶❸ or jack output ❶❷ of the appropriate channel 1 or 2 to the balanced microphone input of the mixing console or amplifier.
- Adjust the level of the audio output to the input level of the amplifier or the mixing console in the menu settings of the appropriate channel. Refer also to chapter 2.7 "Menu Settings".

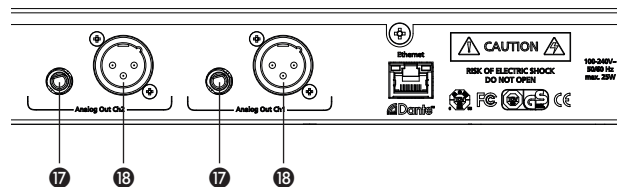

### 2.5.4 How to Connect the Receiver to the Mains/ Disconnect from the Mains

- Verify that the voltage rating of the receiver matches that of the AC mains outlet you are to use.  
**Warning:** If you connect the receiver to the wrong voltage, you may seriously damage it.
- Connect the power cable to the mains connection ❶❹ and to a mains socket.
- To disconnect the receiver from the mains, pull the plug out of the appliance inlet at the rear side of the device.

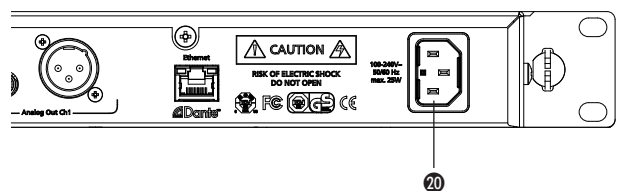

## 2.6 Setting up

### 2.6.1 How to Operate the Receiver

- After having mounted and connected the receiver, turn it on with the on-off switch ③.









#### • Standard Display

The standard display ⑧ for each of the two channels will be shown. If a valid transmitter signal is received on the selected frequency, the display background will be black. If there is no valid transmitter signal available, the colour of the display background will turn white. In this case there will be no audio signal.

- By default it is displayed:
  1. line: the currently selected name (e.g. name of the artist)
  2. line: the currently selected frequency
  3. line: the currently selected frequency group and channel
  4. line: when valid transmitter signal is available: Battery status, transmitter type, microphone capsule and gain in dB  
when no valid transmitter signal is available: No Tx or Enc Err
- All buttons on the front of the receiver are highlighted in white. When a button is pressed or activated, the highlighted light will turn red.
- For turning the receiver off, use the on-off switch ③. The buttons will no longer be highlighted.
- Should the message “Low Batt” be displayed, then the operating of the respective transmitter battery is approx. 30 to 40 minutes. The battery should be replaced.

- If the message “Vers Err” is displayed, the firmware versions of the transmitter and receiver are not the same. There are two possibilities:  
If the display remains black, the firmware has been changed, but does not affect the audio processing, i.e. the audio signal is still available.  
If the display turns white, the audio processing has also been changed, i.e. there is no audio signal available.  
In both cases the firmware of transmitter and receiver must be checked and updated.

#### • Possible icons of the standard display and their meaning

-  A handheld transmitter is used.
-  A belt pack transmitter is used.
-  The “Power Lock” function is activated.
-  The “Encryption” function is activated.
-  “RF Power” has been set to “Standard”.
-  “RF Power” has been set to “High”.
-  It is possible to mute the transmitter.
-  Receiver can be configured with Dante Controller and audio data can be sent

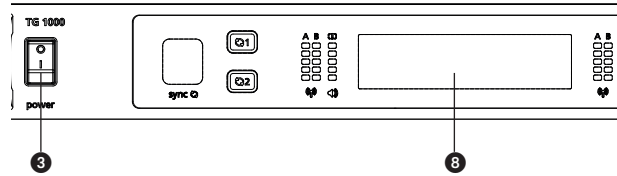

Display when there is a valid transmitter signal available



Display when there is no valid transmitter signal available

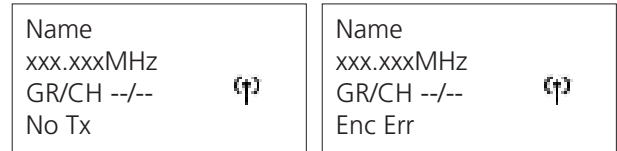

Display when the operating time of the transmitter battery is 30 to 40 minutes

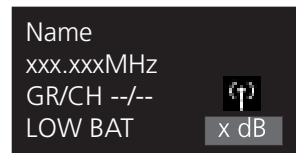

Display when a firmware version error occurs; audio signal is still available

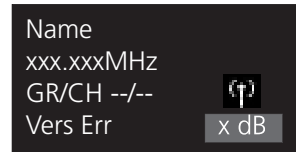

Display when a firmware version error occurs; audio signal is not available

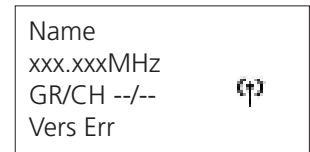



## 2.7 Menu Settings

- On the receiver you can adjust settings for name, frequency group, frequency, gain etc. in different menus for channel 1 or 2.
- Select channel 1 or 2 by pressing the appropriate channel selector button 9.
- When the channel selector button 9 is highlighted in red and the display 8 is changing, you can scroll through the menu by turning the rotary switch 10 and enter the sub-menu by pressing the rotary switch 10 to make some settings and confirm them afterwards. When a setting is confirmed by pressing the rotary switch 10 the "OK" message will be displayed.
- With the ESC button 11 you can cancel the entry within the menu or sub-menu. The entries are not accepted and the original entries will be displayed.
- **Caution:** If you do not operate the rotary switch 10 for a few seconds, the appropriate sub-menu will automatically be left and the default screen will be displayed 8. Settings, which are **not** confirmed by pressing the rotary switch 10 will not be stored.
- On the right hand side of the individual sub-menus the channel is displayed for which the settings can be done, i.e. "1" or "2".
- **Note:** If a setting (except "Handheld Gain" and "Beltpack Gain") is changed, the appropriate button of synchronisation 5 will illuminate red.

The following settings are possible:

### Meter

Here you can display the audio and RF level in a combination for channel 1 and channel 2. You can also display the RF level and audio level for both channels separately when the transmitters are turned on.

Press the rotary switch 10 to access the submenu.

At first the combined audio and RF level will be displayed. When channel 1 is selected, it will be displayed.

When you turn the rotary switch 10 further to the right, the combined audio and RF level for channel 2 will be displayed.

If channel 2 has been selected, the combined level for channel 2 will directly be displayed.

### RF level display

When you turn the rotary switch further to the right, the RF level is displayed for channel 1 and 2. The RF level is displayed by bars.

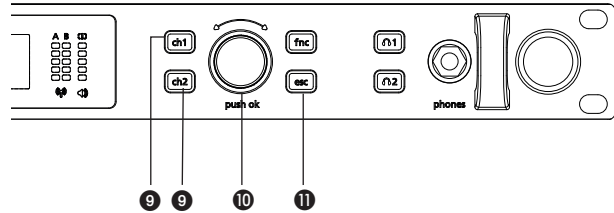

Select the "Meter" submenu



Combined audio and RF level display – transmitter turned off



Combined audio and RF level display – transmitter turned on

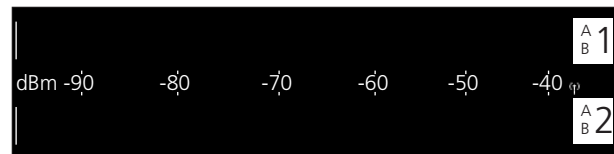

RF level display – transmitter turned off



RF level display – transmitter turned on

Interference of the transmitted signal is displayed by inversion of the "1 A/B" or "2 A/B" channel description.



RF level display – interference on channel 1

**Audio level display**

If you turn the rotary switch further to the right, the audio level for channel 1 and 2 will be displayed each by a bar.

When the transmitter is muted, the channel description "1" or "2" will be inverted.

**Note:**

The display of the "Meter" submenu is not automatically finished. For further settings of the appropriate channel, press the button "ch 1" or "ch 2".

If you want to change into the menu for function settings, press the "fnc" button.

If you want to return to the standard display, press the "ESC" button.



Audio level display – transmitter turned off



Audio level display – transmitter turned on



Audio level display – transmitter muted on channel 1

• **Name**

Here you can enter the name of the artist.

Press the rotary switch 10 to enter the sub-menu. Turn the rotary switch 10 to the left or right to select the letter/character. Press the rotary switch 10 to confirm.



Select the "Name" submenu



Select letter/character

• **Frequency Group (GR) / Channel (CH)**

Here you can select a channel or frequency from a predefined frequency group according to the respective region code (A, B, C, D or E).

Press the rotary switch 10 to enter the sub-menu. Turn the rotary switch 10 to the left or right to select the requested group. You can select between robust and standard frequency groups. In a robust group there are less channels with a bigger frequency spacing. This prevents interference of the transmitters among each other.

In a standard group there are more channels with a closer frequency spacing, which can cause interference of the transmitters among each other.

We recommend using a robust frequency group.

From the information at the bottom you can see how many channels are in the appropriate group. Press the rotary switch 10 to confirm.

Then turn the rotary switch 10 to the left or right to select the requested channel from the previously selected group. From the information at the bottom you can see the appropriate frequency. Press the rotary switch 10 to confirm.

**Note:**

While selecting the frequency group and channel, the RF display 6 on the front of the receiver is active so that possible interferences of the selected frequency, such as another transmitter with the same frequency, are displayed.

As a user you can generate groups ("User Groups") with appropriate channels and frequencies by using the "Chameleon" software, with which you can enter the groups into the receiver. These groups are marked with a "U".

• **Frequency**

Depending on the region code, you can manually select a frequency between 470 and 789 MHz regardless whether it is in a group or not.

If you select a frequency manually, it is displayed in the default screen by "GR / CH --/--".

Press the rotary switch 10 to enter the sub-menu. Turn the rotary switch 10 to the left or right to select the first three numbers of the requested frequency. Press the rotary switch 10 to confirm.

Turn the rotary switch 10 to the left or right to select the last three numbers of the requested frequency. Press the rotary switch 10 to confirm.

**Note:**

While selecting the frequency group and channel, the RF display 6 on the front of the receiver is active so that possible interferences of the selected frequency, such as another transmitter with the same frequency, are displayed.



Select the "Frequency Group (GR) / Channel (CH)" submenu

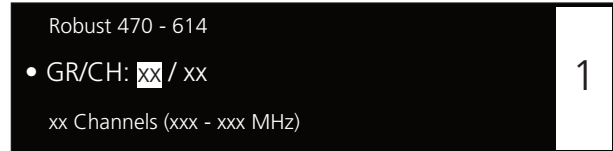

Select "Frequency Group (GR)"



Select "Channel (CH)"

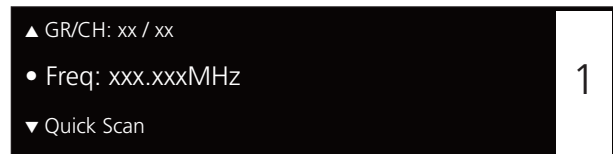

Select the "Frequency" submenu

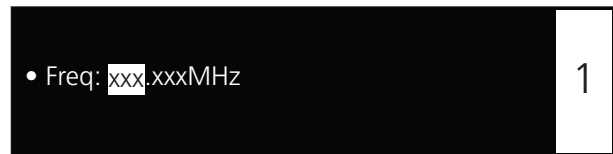

Select frequency

• **Quick Scan**

Here you can select a channel or frequency from a predefined group according to the respective region code (A, B, C, D or E).

Press the rotary switch **10** to enter the submenu. Turn the rotary switch **10** to the left or right to select the requested group. From the information at the bottom you can see how many channels the group contains. Press the rotary switch **10** to confirm the selected group.

Now you can select a frequency group which can be scanned for a channel. From the information at the bottom you can see how many channels the group contains. Press the rotary switch **10** to confirm the selected group.

Now you can select a channel from the previously selected group from which to start the scanning. From the information at the bottom you can see the frequency of the selected channel. Turn the rotary switch **10** to the left or right to select the requested channel. Press the rotary switch **10** to confirm the selected channel. The message “Scanning” will be displayed.

After the scanning, the next free channel will automatically be selected. The selected channel and its frequency are displayed.

If you have selected the “Set All Ch in Network” option, the “Frequency setting sent” message will be displayed when the channel and appropriate frequencies have been sent to all receivers in the network.

After the scanning, the existing receivers in the network will display an information to select (Yes) or reject (No) the found frequency for the receiver. Turn the rotary switch **10** to the left or right to select “Yes” or “No”. Press the rotary switch **10** to confirm your selection.

No = the existing frequencies for the channels will be maintained

Yes = the existing frequencies for the channels will be overwritten  
The receiver from which the “Quick Scan” function was started, will accept the found frequency in any case.

**Important:**

After performing the “Quick Scan” function, you must synchronise the transmitter/s again. Refer also to chapter 2.10 “Synchronisation”.

**Note:**

As a user you can generate groups (“User Groups”) with appropriate channels and frequencies by using the “Chameleon” software, with which you can enter the groups into the receiver. These groups are marked with a “U”.



Select the “Quick Scan” submenu



Perform the “Quick Scan” only for channel 1 OR for all channels in the network

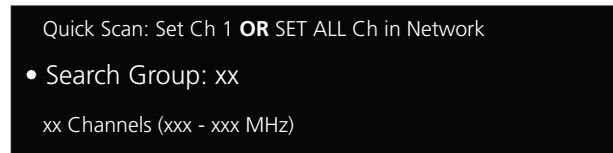

Select the group which shall be scanned for a channel

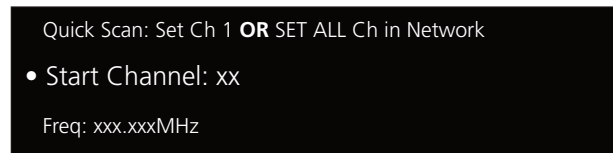

Select the channel from which the scan shall be started

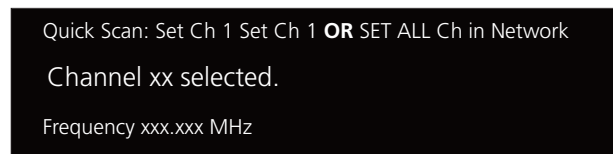

Display the selected channel and the appropriate frequency after the scan

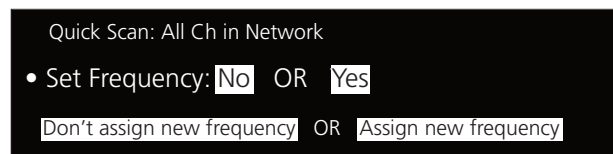

Display of the receivers in the network after the scan and frequency transmission

• **Handheld Gain**

Here you can digitally adapt the level of the audio output to the input level of the amplifier or mixing console, i.e. if the signal, which is picked up with the handheld microphone is very low, it can be amplified with "Handheld".

Press the rotary switch ⑩ to enter the submenu. Turn the rotary switch ⑩ to the left or right to select the amplification in 3 dB steps between 0 dB and +42 dB. Press the rotary switch ⑩ to confirm.

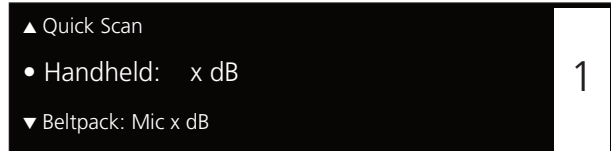

Select the "Handheld" submenu

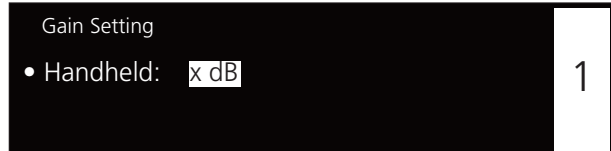

Set the gain for the signal picked up by the handheld transmitter

• **Beltpack Gain**

Here you can analogously adapt the level of the audio output to the input level of the amplifier or mixing console, i.e. if the signal, which is picked up with the beltpack transmitter is very low, it can be amplified with "Beltpack Gain".

When a microphone is connected to the beltpack transmitter, select the menu item "Beltpack: Mic" and set the gain on the beltpack transmitter to 0 dB.

Especially when you connect instruments directly to the beltpack transmitter, the amplification should be selected via "Beltpack: Instr Pas 0 dB" for passive instruments such as guitars or "Beltpack: Instr Act 0 dB" for active instruments such as E-bass.

On the beltpack transmitter you must select the gain with the AF gain switch ⑧ as well: passive instruments = 0 dB; active instruments = -12 dB

Press the rotary switch ⑩ to enter the sub-menu.

If a microphone is connected to the beltpack transmitter, turn the rotary switch ⑩ to the left or right in the "Microphone Mode" for "Beltpack: Mic" to select the gain in 3 dB steps between 0 dB and +42 dB.

If an instrument is connected, turn the rotary switch ⑩ to the left in the "Microphone Mode" below 0 dB until "Beltpack: Instr Pas 0 dB" or "Beltpack Instr Act 0 dB" is displayed.

Press the rotary switch ⑩ to confirm.

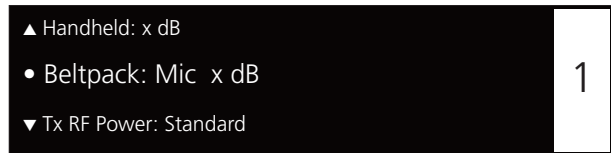

Select the "Beltpack" submenu

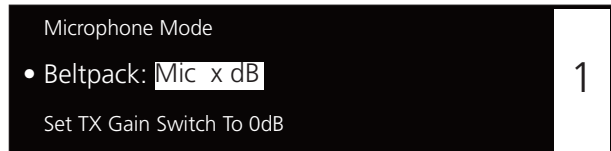

Set the gain for the signal picked up by the beltpack transmitter when a microphone has been connected

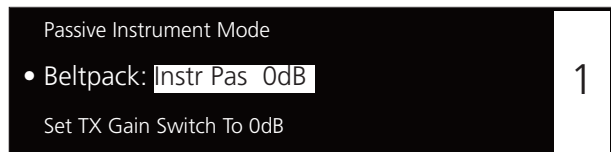

Set the gain for the signal picked up by the beltpack transmitter when a **passive** instrument has been connected

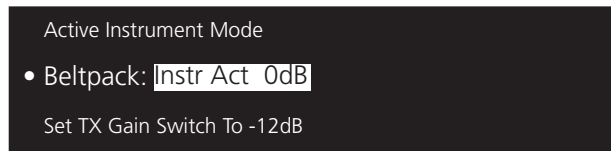

Set the gain for the signal picked up by the beltpack transmitter when an **active** instrument has been connected

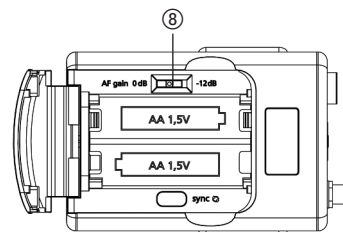

• **Tx RF Power**

Here you can set the Tx RF power.

The “Standard” setting is recommended when the transmitter is close to the receiving antennae or with multi-channel systems to avoid interferences due to intermodulation.

“Standard” is displayed by the following symbol: 

The “High” setting is recommended when there are problems with the range or with a larger distance between transmitter and receiving antennae.

“High” is displayed by the following symbol: 

Press the rotary switch **10** to enter the sub-menu. Turn the rotary switch **10** to the right or left to adjust the desired Tx RF power to “High” or “Standard”. Press the rotary switch **10** to confirm.

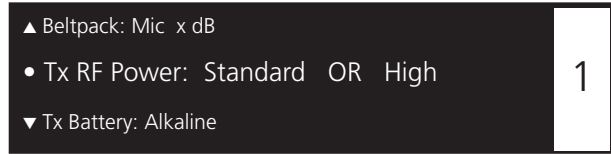

Select the “Tx RF Power” submenu

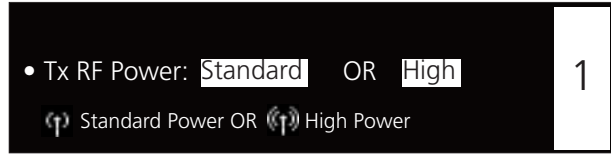

Select “Standard” or “High” RF power

• **Tx Battery**

Here you can select, if there is an alkaline battery or NiMH rechargeable battery inside the transmitter so that the battery status is displayed **8** correctly.

Press the rotary switch **10** to enter the sub-menu. Turn the rotary switch **10** to the right or left to select the inserted battery: “Alkaline” or “NiMH”. Press the rotary switch **10** to confirm.

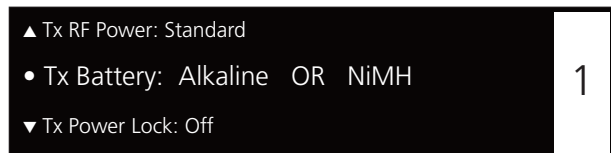

Select the “Tx Battery” submenu

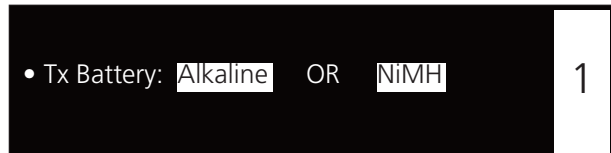

Select alkaline or NiMH battery

• **Tx Power Lock**

Here you can set if the transmitter can be switched off via its on-off button or not. When the “Tx Power Lock” function is enabled (On), the transmitter cannot be accidentally turned off and the following symbol is displayed: 

However, the transmitter can be turned off when the “Tx Power Lock” function is activated: When the transmitter display shows the message “Tx Power Locked”, release the on-off button and press the on-off button once again until the “Off” message is displayed.

Press the rotary switch **10** to enter the menu. Turn the rotary switch **10** to the right or left to enable (On) or disable (Off) the “Tx Power Lock” function. Press the rotary switch **10** to confirm.

**Important:** After having confirmed the selected option, you must synchronise the transmitter again. Refer also to chapter 2.10 “Synchronisation”.

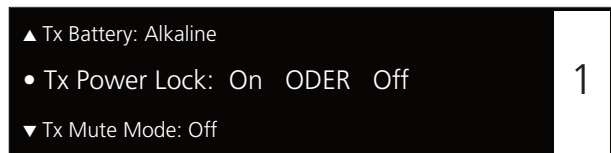

Select the “Tx Power Lock” submenu

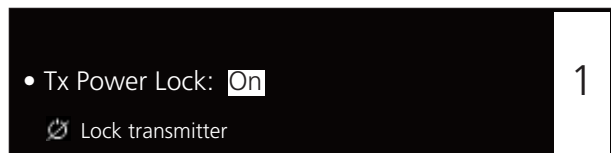

Activate the “Tx Power Lock” function



Deactivate the “Tx Power Lock” function

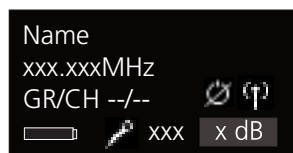

Standard display receiver:  
“Tx Power Lock” function activated

• **Tx Display**

Here you can select if the transmitter display is always on or if the display of the transmitter is automatically turned off (e.g. for TV shows where the bright display could be disturbing).

When you select the “Auto Off” option, the transmitter display will be turned off after approx. 6 seconds.

By briefly pressing the on-off button on the transmitter itself, you can briefly activate the display for reading.

If you hold down the on-off button, the transmitter is turned off after activating the display of the transmitter.

If the transmitter is in the “Tx RF off” or “Tx Mute” mode, the display is not turned off despite the “Auto Off” function. In the “Tx RF off” mode the display is dimmed; in the TX Mute mode the display is flashing.

Press the rotary switch 10 to enter the menu. Turn the rotary switch 10 to the right or left to disable (Auto Off) or to leave the display enabled (Always On). Press the rotary switch 10 to confirm.

**Important:** After having confirmed the selected option, you must synchronise the transmitter again. Refer also to chapter 2.10 “Synchronisation”.

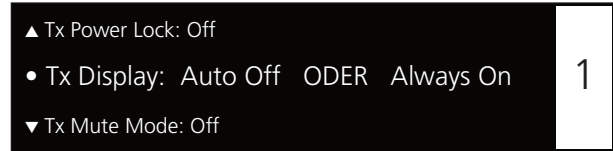

Select the “Tx Display” submenu



Select the “Auto Off” function

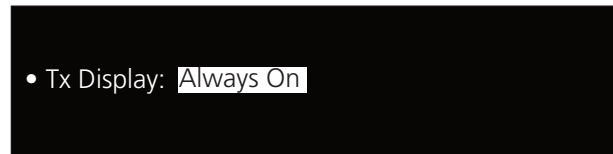

Select the “Always On” function

• **Tx Mute Mode**

Here you can select if the transmitter can be muted via its on-off switch or not.

When the “Tx Mute Mode” function is activated (ON), the transmitter can be muted by using the on-off switch and the following symbol is displayed: 

When the “Tx Mute Mode” function is to be deactivated so that the transmitter cannot be muted via the on-off switch, select “Off”.

Press the rotary switch 10 to enter the menu. Turn the rotary switch 10 to the right or left to enable (On) or disable (Off) the “Tx Mute Mode” function. Press the rotary switch 10 to confirm.

**Important:** After having confirmed the selected option, you must synchronise the transmitter again. Refer also to chapter 2.10 “Synchronisation”

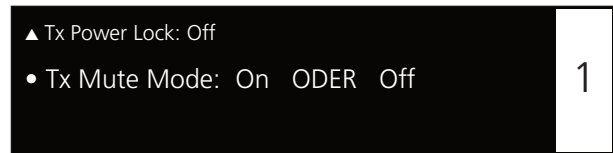

Select the “Tx Mute Mode” submenu

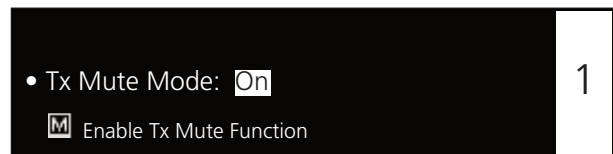

Activate the “Tx Mute Mode” function

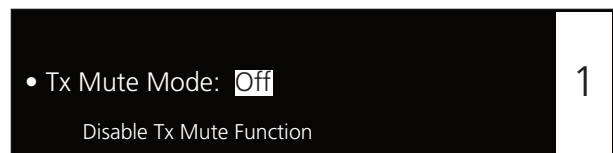

Deactivate the “Tx Mute Mode” function

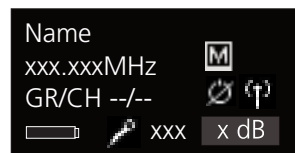

Standard display receiver:  
“Tx Mute Mode” function activated

• **Encryption**

Here you can activate or deactivate the encryption of audio data. The encryption is used to avoid unauthorised listening.

Press the rotary switch **10** to enter the sub-menu. Turn the rotary switch **10** to the right or left to activate (On) or deactivate (Off) the encryption. Press the rotary switch **10** to confirm.

**Important:** When you activate the encryption function (On) the receiver will generate a code. In order to communicate with each other the receiver and transmitter must have the same code. Therefore, you must synchronize receiver and transmitter. Refer also to chapter 2.10 "Synchronisation".

**Caution:** Each time when you activate the encryption function again (On), a new code will be generated which must be transmitted to the transmitter.

If the transmitter and receiver do not have the same code or if an unencoded receiver tries to receive an encoded transmitter, the receiver displays the message "Enc Err" and the background of the display will turn white.

When the encryption function is activated, a lock symbol will be displayed: 



Select the "Encryption" submenu



Activate the encryption



Deactivate the encryption

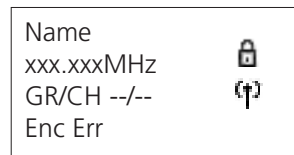

Standard display receiver:  
Activated encryption  
Code for transmitter / receiver are **not** the same

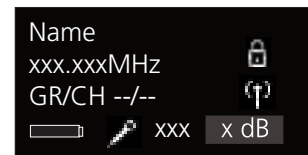

Standard display receiver:  
Activated encryption  
Code for transmitter / receiver are the same



## 2.8 Function Settings

- On the receiver you can adjust settings when the receiver is operating in a network or you can update the firmware of the transmitters. Furthermore, you can display information about support. For the functions described in the chapters 2.8.1 to 2.8.7 the receiver must be turned on and connected to a network via the Ethernet interface 19.
- Press the function button (fnc) 12.
- When the function button 12 is highlighted in red and the display 6 is changing, turn the rotary switch 10 to scroll through the menu and press the rotary switch 10 to enter the sub-menu for settings which you can confirm afterwards. When a setting is confirmed by pressing the rotary switch 10, the message "OK" is displayed.
- With the ESC button 11 you can cancel the entry within the menu. Then the settings will not be accepted and the original settings will be reset.
- **Caution:** When you do not operate the rotary switch 10 for a few seconds the menu will automatically be left and the default screen will be displayed 8. Settings which are **not** confirmed by pressing the rotary switch 10 will not be stored.
- In the individuals menus "f" will be displayed on the right hand side to indicate function.

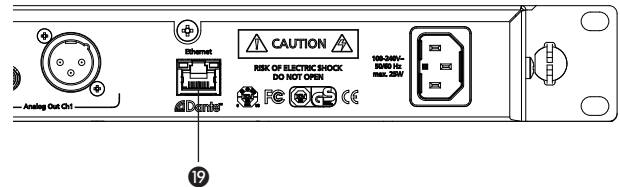
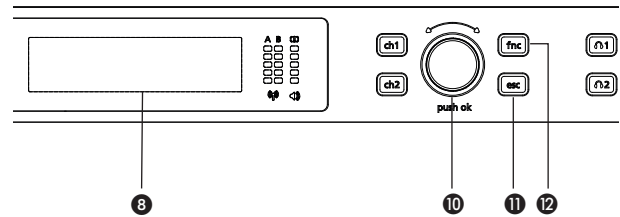

### 2.8.1 How to Connect a Receiver to a Network

- When you connect a receiver to a network, use a CAT5 patch cable to connect the receiver via the Ethernet and Dante interface 19. Turn on the receiver. For using wireless devices (e.g. tablet PC, iPhone, iPad etc.) a Wi-Fi network is needed. You can connect the receiver to a switch or router with DHCP server. Make sure that in the network, there is only one DHCP server active. If the router is operated as Access Point in a Wi-Fi network, you can access the receiver with Wi-Fi devices.

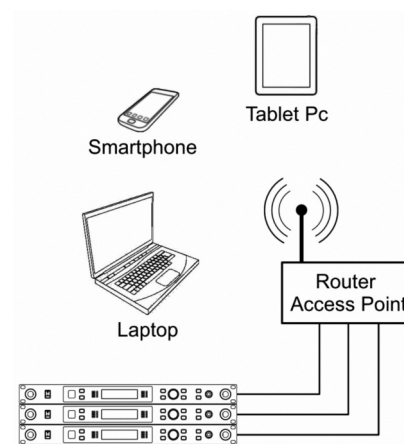
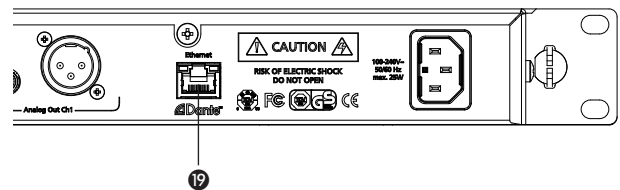

- Adjust the settings for the network on the receiver as described in the following.
- Press the function button **12**. “Network” is displayed **8**. Press the rotary switch **10** to enter the “IP” sub-menu.

### IP

- In the “IP” sub-menu you can display the IP address assigned to the receiver and change it if necessary. The IP address consists of 4 bytes. Each byte consists of three numbers (from 0 to 255). If you want to assign the IP address manually, select the “Manual” function in the “Mode” sub-menu (refer also to the “Mode” paragraph). Afterwards select the “IP” sub-menu by turning the rotary switch **10** to the left and press the rotary switch **10** to access the sub-menu.  
Turn the rotary switch **10** to the right or left to select a value between 0 and 255. Press the rotary switch **10** to confirm the first byte and to go to the next byte. Repeat the last two steps to enter all four bytes. When you have set the IP address, press the rotary switch **10** to confirm.



Select the “Network” main menu

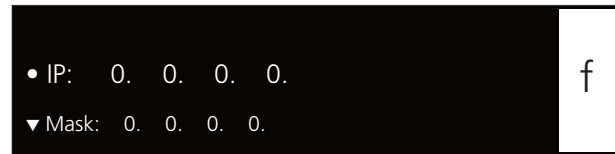

Select the “IP” submenu

### Mask

- In the “Mask” sub-menu you can display or change the net mask assigned to the receiver. The net mask consists of 4 bytes. Each byte consists of max. three numbers (from 0 to 255). In conjunction with the IP address of the receiver the net mask determines which IP addresses the device is searching in its own net and which it could reach via a router in other networks. It separates the IP address into a net prefix and component. The net prefix must be the same with all devices within the net, the component of each device within the network must be different. In order to manually assign a net mask, select “Manual” function in the “Mode” sub-menu (refer also to the “Mode” paragraph). Turn the rotary switch **10** to the left and select the “IP” sub-menu and press the rotary switch **10** to enter the sub-menu.  
Turn the rotary switch **10** to the right or left to select a value between 0 and 255. Press the rotary switch **10** to confirm the first byte and go to the next byte. Repeat the last two steps to enter all four bytes. When you have set the net mask, press the rotary switch **10** to confirm.

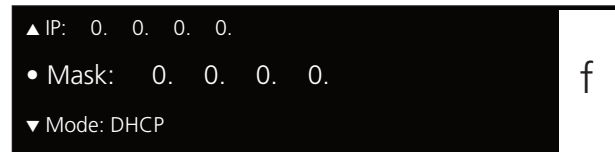

Select the “Mask” submenu

**Mode**

- Turn the rotary switch 10 to the right and press the rotary switch 10 to access the “Mode” sub-menu. By pressing and turning the rotary switch 10 you can select “DHCP” or “Manual”. To confirm the selection press the rotary switch 10.

In a network you can use both switches and routers with DHCP server. Please note that only one DHCP server in the network is active due to the allocation of IP addresses.

If you use a router with a DHCP server, select “DHCP”. Then the automatic integration of the receiver to an existing network without the manual configuration is possible. When starting the receiver it can get the IP address, the net mask, the gateway, DNS server and if necessary WINS server from a DHCP server. With the automatic assignment a range of IP addresses is defined on the DHCP server. This area is set in a router with DHCP server. If the address is out of this range allocated to a DHCP client, then it belongs to, whichever is defined “Lease time” in the DHCP server (router), which determines the duration of the assignment between IP address and MAC address.

If you use a switch or router without an active DHCP server, select “Manual”. You can set the IP address in the “IP” menu manually.

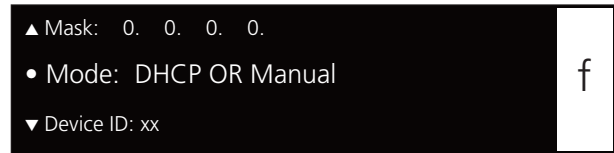

Select the “Mode” submenu

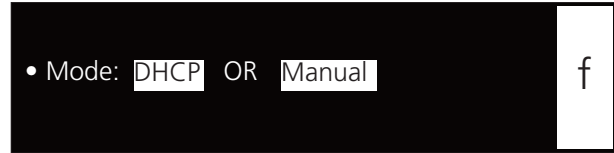

Select “DHCP” or “Manual”

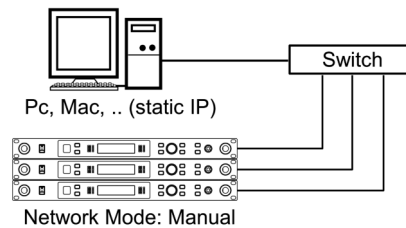
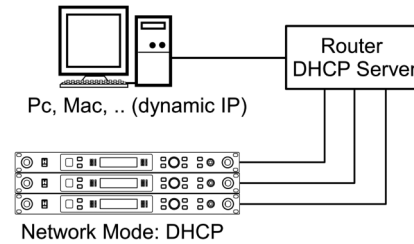

**Device ID**

- Turn the rotary switch 10 to the right and press the rotary switch 10 to access the “Device ID” sub-menu. Here you can select the Device ID (1 - 99) of the receiver by pressing and turning the rotary switch 10. To confirm press the rotary switch 10.

The Device ID defines the allocation of the devices in the “Chameleon” software. In the basic view of the software the devices are displayed one below the other similar to a rack with ascending Device ID.

**Important:** Please note that you can change the Device ID **only** on the receiver. Make sure that you do not assign the same Device ID twice.

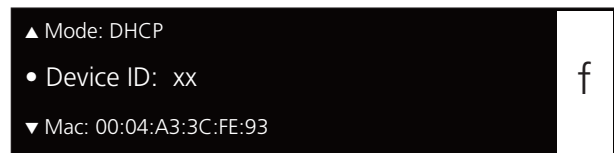

Select the “Device ID” submenu



Set the “Device ID”

**Mac**

- Turn the rotary switch 10 to the right and read the MAC (Media Access Control) address in the “Mac” sub-menu of the receiver. The MAC address is stored in the receiver and cannot be changed. Each receiver has a different MAC address. This ensures that in a network with a DHCP server each receiver gets a different IP address.

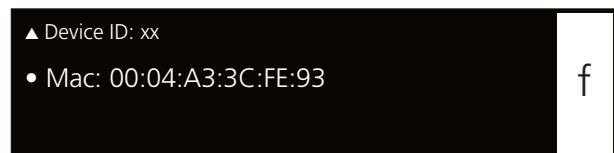

Select the “Mac” submenu

### 2.8.2 Dante™ Audio Network

In order to operate a receiver within a Dante audio network, you need the Dante Controller software application from the company Audinate. Please also refer to the separate manual “Dante Controller User Guide” of the company Audinate.

**Please note:**

Models of the TG 1000 receiver with a simple Ethernet connection cannot be operated in a Dante™ Audio Network. In order to make use of the Dante™ Audio Network, the TG 1000 receiver must be fitted with an Ethernet/Dante network connection.

- Press the function button **12**. Select the sub-menu “Dante Audio Network” by turning the rotary switch **10**. Press the rotary switch **10** to enter the sub-menu.
- In the sub-menu there are more menu options available.

In the **Dante ID** menu you can see the “TG 1000-01” Dante ID set at the factory. For a better assignment in the “Dante Controller” software application, when using several receivers, we recommend labelling them appropriately. Press the rotary switch **10** again and enter the desired ID by turning and pressing the rotary switch **10**. In order to leave the “Dante ID” sub-menu press the rotary switch **10**.

- The “Sample Rate” menu displays the currently selected sample rate. If you would like to change it, use the Dante Controller. For more information, please refer to the separate manual “Dante Controller User Guide” of the company Audinate.
- The “Network Info” menu displays the network information of the Dante audio network such as IP address, netmask, gateway and link (display of the link). For more information, please refer to the separate manual “Dante Controller User Guide” of the company Audinate.

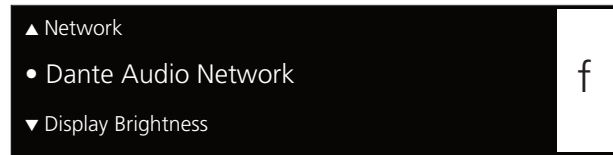

Select “Dante Audio Network” sub-menu

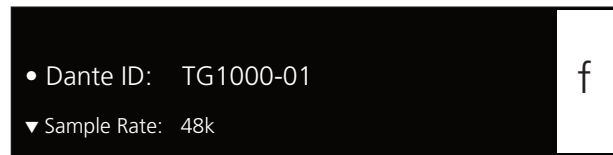

Select “Dante ID” sub-menu

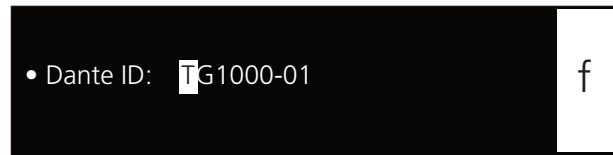

Change Dante ID

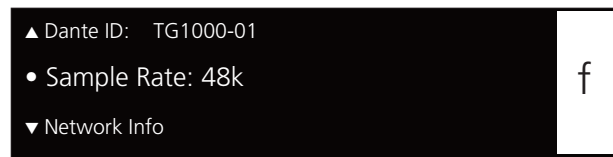

Display “Sample Rate” sub-menu item



Select “Network Info” sub-menu item

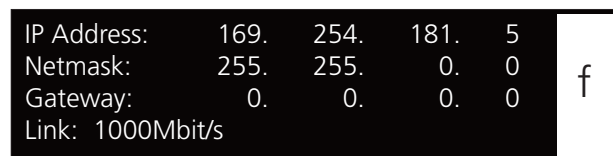

Display Dante network information

### 2.8.3 How to Set the Brightness of the Display

- In order to set the brightness of the display of the receiver, press the function button **12**. Select the “Display Brightness” submenu by turning the rotary switch **10**. Press the rotary switch **10** to access the submenu.
- Turn the rotary switch **10** to select the desired brightness. In order to confirm press the rotary switch **10**. If you do not set the display to minimum brightness, the display is dimmed after a certain time.
- **Warning:** When the maximum brightness has been selected, after a longer time an image burn of the display is caused due to the design. In order to ensure a long lifetime of the display, we recommend selecting the setting as bright as needed and as dark as possible.

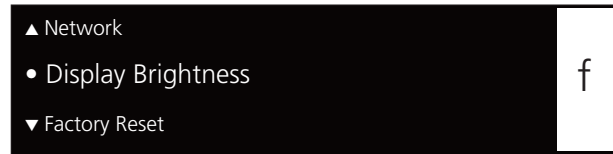

Select the “Display Brightness” submenu



Set the brightness of the receiver display

### 2.8.4 Settings for the Receiver Display

- For the receiver display you can enter various settings.

With the “**Rx Display: Always On**” default setting, the display is always on.

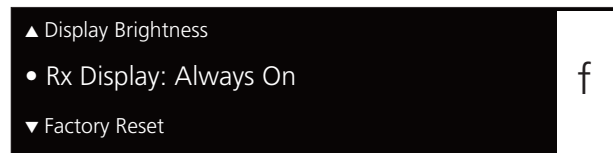

Select “Rx Display:” sub-menu

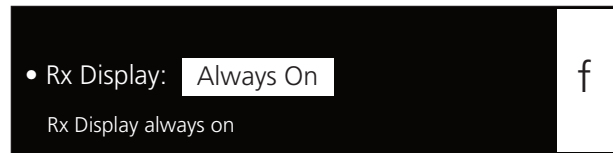

Select “Rx Display: Always On” sub-menu

With the “**Rx Display: Scr Saver**” setting, a screen saver is turned on after a few minutes, i.e. the display turns black after a few minutes and an illuminated square is moving across the display. As soon as a button is pressed or a transmitter is active, the display becomes active. In order to protect the OLED display the “Rx Display: Scr Saver” is recommended.

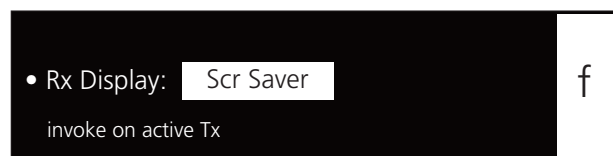

Select “Rx Display: Scr Saver” sub-menu

With the “**Rx Display: Auto Off**” setting, the display turns black after a few minutes and an illuminated square is moving across the display. As soon as a button or the rotary switch **10** is pressed, the display becomes active again. The “Rx Display: Auto Off” setting is recommended with permanent installations when the receiver is in a separate technical room or operated via the Chameleon software or the wireless manager.

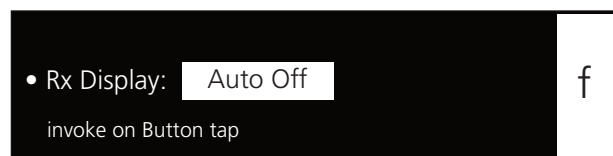

Select “Rx Display: Auto Off” sub-menu

- Press the function button **12**. Select the “Rx Display:” sub-menu by turning the rotary switch **10**. Press the rotary switch **10** to access the sub-menu.
- Turn the rotary switch **10** to set the desired display activity. To confirm press the rotary switch **10**.

### 2.8.5 Factory Reset

- For a factory reset press the function button **12**. Select the "Factory Reset" sub-menu by turning the rotary switch **10**. Press the rotary switch **10** to access the sub-menu.
- Turn the rotary switch **10** to select, if you want to reset the factory or standard settings or not. Press the rotary switch **10** to confirm.

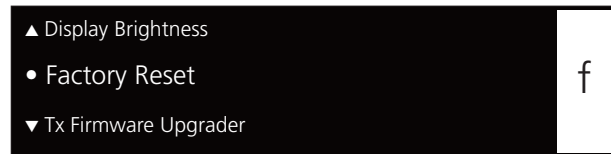

Select the "Factory Reset" submenu

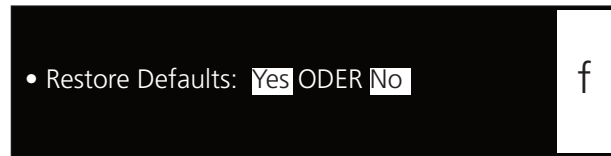

Restore default settings: yes or no

### 2.8.6 How to Display the Version and Region Code

- In order to display the version and region code press the function button **12**. Select the "Version Info" sub-menu by turning the rotary switch **10**. Press the rotary switch **10** to access the sub-menu.
- Here you can read the current firmware version of the receiver and the used transmitters.  
**Important:** The transmitters must be **switched on**.
- With the Region Code you can recognise which predefined frequency ranges are provided for which regions in the TG 1000 system:
  - Region Code: A 470 - 789 MHz
  - Region Code: B 470 - 698 MHz  
(without 608 - 614 MHz / US TV channel 37)
  - Region Code: C 520 - 694 MHz
  - Region Code: D 470 - 638 MHz & 650 - 758 MHz
  - Region Code: E 470 - 714 MHz

**Note:** The Region Code is subject to changes!

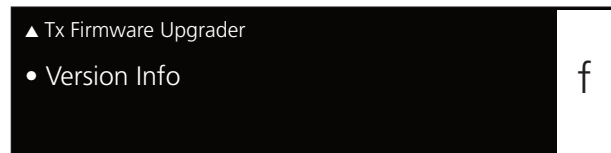

Select the "Version Info" submenu

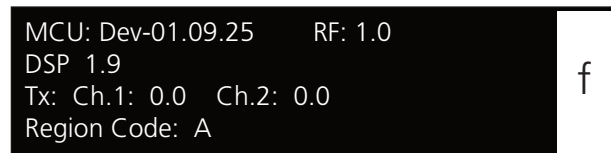

Display the Firmware Version and the Region Code

### 2.8.7 How to Update the Firmware of the Receiver

- You can update the firmware of the receiver with the so-called “Bootloader” via the network.
  - You will find the appropriate update of the firmware (for receiver and transmitters) and the Chameleon software on the internet at: [www.beyerdynamic.com/tg1000/help](http://www.beyerdynamic.com/tg1000/help)
  - Download this update file on your PC.
  - Connect the receiver via the Ethernet interface 19 to a PC by using a CAT5 patch cable.
- 
- In order to start the Bootloader mode, press the rotary switch 10 while turning the receiver on.
  - When you press the function button 12, you can check or adapt the network settings. Refer also to chapter 2.8.1 “How to Connect a Receiver to a Network”.
  - Enter the IP address, which is displayed on the receiver, into an internet browser.
  - In the internet browser a page will be opened where you can load the new firmware as file into the receiver.
  - Select the “Select file” button and select the file from the opened window.
  - Select the “Submit” button to confirm.
  - The receiver displays the transmission status.
  - When the message “Upgrade successful” is displayed on the PC, the transmission to the receiver is finished.
  - Turn the receiver off and on again to start the firmware upgrade. The message “Rx Firmware Upgrading” is displayed 8.
  - The upgrade is ready, when the default screen is displayed 8.

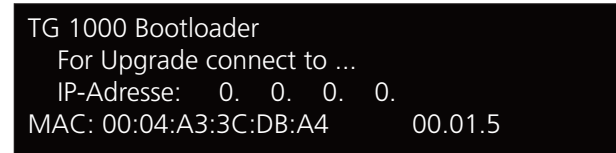
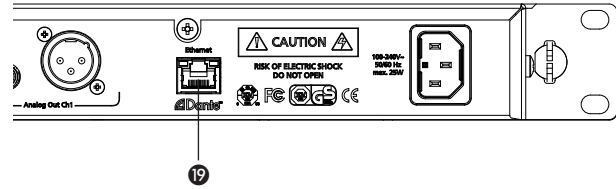

Perform the Firmware Update of the receiver

### 2.8.8 How to Update the Firmware of the Transmitter

- In order to update the firmware of the transmitter, please proceed as described in the following.
- Press the function button 12. Select the “Tx Firmware Upgrader” submenu by turning the rotary switch 10. Press the rotary switch 10 to access the submenu.

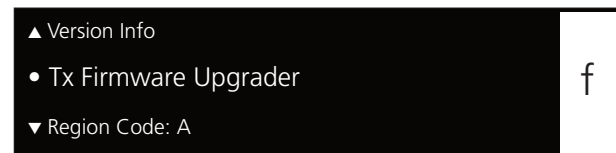

Select the “Tx Firmware Upgrader” submenu

- Press the rotary switch 10 to start the updating process. Follow the displayed instructions 8 and press the rotary switch 10 each time to confirm.
- Switch on the transmitter and hold the infrared interface of the transmitter directly in front of the infrared interface of the receiver (refer also to chapter 2.10 “Synchronisation”).

**Important:** Please note that the infrared interface of the transmitter must be held in front of the interface of the receiver during the whole updating process, otherwise the updating process will be stopped. Therefore, we recommend a secure position in front of the infrared interface of the receiver, because the updating process will take several minutes. Make sure that the batteries inside the transmitter are not empty. Furthermore, the transmitter and receiver should be shielded from other light sources such as LED light walls. Should the updating process stop (display of the “Upgrade Error” message), it can be restarted without any problems. When the update of the firmware is successful, the “Upgrade successful” message will be displayed.

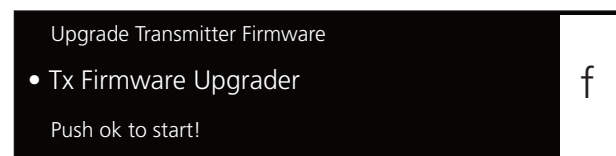

Start the “Tx Firmware Upgrader” submenu



Progress of the upgrade of the transmitter firmware

## 2.9 Monitoring

- For monitoring purposes you can listen to channel 1 or 2 or a mix of channel 1 and 2 via headphones.
- Connect a headphone to the headphone connection 14 of the receiver.
- Press the appropriate button 13 to monitor channel 1 or 2 or both buttons to monitor a mix of both channels. When the function is activated, the appropriate button is highlighted red.

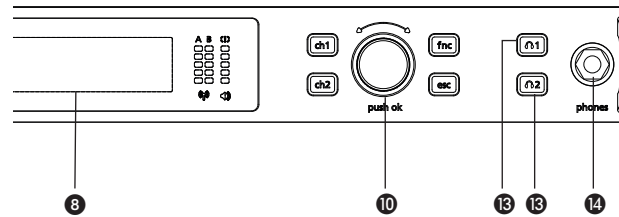

- In the monitoring menu you can set the volume in 3 dB steps between -33 and +30 dB with the rotary switch 10.

**Warning: Do not set the volume too high, you can damage your hearing permanently.**

- You can read the volume on the display 8.
- After a while the display 8 returns to the default screen or, when activated, to the screen saver. The monitoring function or headphone output is still active.
- If you want to listen to a mix of both channels, press the button 13 for channel 1 and 2 to activate the function. Both buttons are highlighted red.
- By pressing the rotary switch 10 you can select channel 1, channel 2 or a mix (channel 1 and 2). By pressing the rotary switch 10 you can change the volume for channel 1 or channel 2 or the mix. Set the volume for one channel and then for the other. If the volume of both channels is different, this difference in volume is also maintained when setting the volume of a mix of channel 1 and 2.

**Example:** Channel 1 = -3 dB, channel 2 = -9 dB

The difference of 6 dB between both channels is maintained when changing the mix.

- In order to mute the monitoring function, press the appropriate button 13. The "OFF" message is displayed 8 for the appropriate channel and the button 13 is highlighted white. Then the monitoring function or the headphone output is turned off. When you turn on the monitoring function again, the previous volume setting is restored.

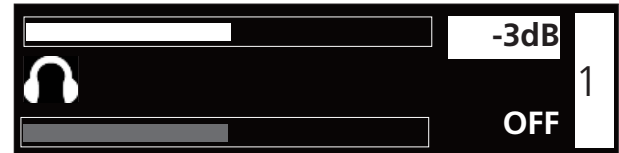

Set the volume for channel 1

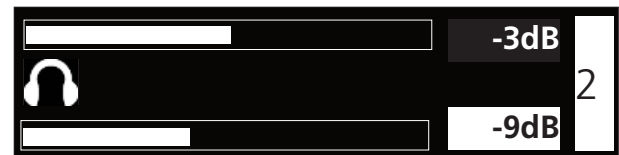

Set the volume for channel 2



Set a volume mix for channel 1 and channel 2

### Warning:

We would like to point out that long listening at high volumes can damage your hearing. A hearing damage always represents an irreversible impairment. Therefore, please reduce the volume before use.

Always make sure that the volume is not too high. Rule of thumb: the higher the volume, the shorter the listening time. According to the professional association regulations on safety and health at work (BGV B3) in Germany, noise pollution at workplace must not exceed 85 dB (low volume). This corresponds to an allowed maximum listening time of 8 hours. If the volume is increased by 3 dB, the allowed listening time is halved, i.e. at 88 dB the duration is 4 hours, at 91 dB 2 hours etc.



## 2.10 Synchronisation

- Via an infrared interface the receiver can transmit frequency and other settings such as encryption and “Power Lock” of the appropriate channel to a transmitter.
  - In order to transmit the settings to a transmitter, press the button for synchronisation 5 for channel 1 or 2 on the receiver.
  - Inside the battery compartment of the transmitter there is an infrared interface.
  - When you have changed a setting and the button for synchronisation 5 is highlighted red, a new synchronisation is required.
  - For synchronisation hold the infrared interface of the handheld transmitter 6 or the beltpack transmitter 10 in the **open battery compartment** of the **switched on** transmitter directly in front of the infrared interface 4 of the receiver.
- Important:** Should the battery symbol in the display of the transmitter flash, the batteries are almost empty and the synchronisation should not be performed, because it will be incomplete or stop.
- When the message “SYNC successful” is displayed, the process is completed. Frequency and other settings have been successfully transmitted to the transmitter.

### How to Synchronise Two Transmitters on the Same Channel

- Press the on-off button of the handheld 8 or beltpack transmitter for approx. 8 seconds to enter the “RF off” mode. Now you can synchronise a spare transmitter on the same channel, although the main transmitter is still activated (audio will still work when synchronising).
  - Synchronise the spare transmitter as described above.
  - In order to leave the “RF off” mode switch the transmitter off and on again.
- Important:** Before you switch the spare transmitter off and on again, you must turn off the main transmitter, because otherwise the channel can be interfered when two transmitters are simultaneously active on the same frequency.

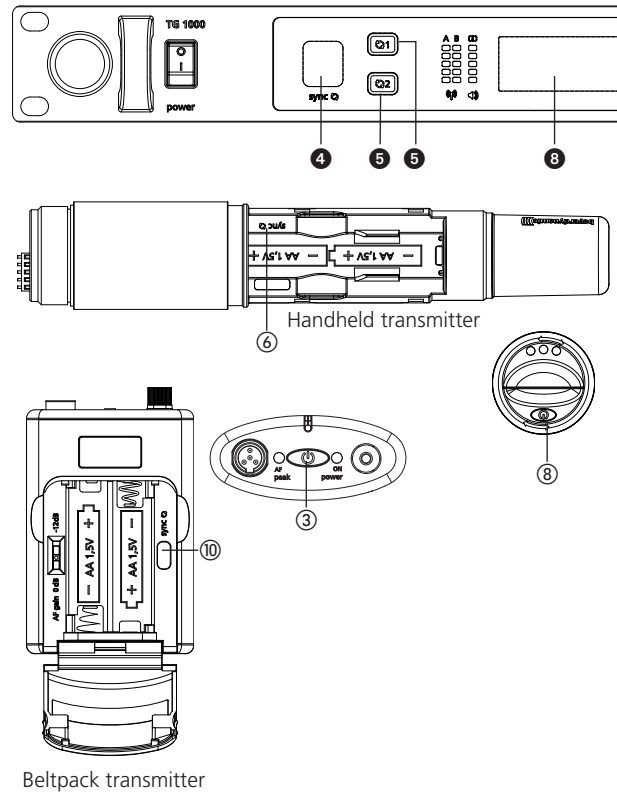

## 2.11 Multi-Channel Operation (Cascading Several TG 1000 Receivers)

- The receiver is provided with an integrated active antenna splitter.
  - For a multi-channel operation with two antennae you can connect 6 receivers (12 channels) at maximum.
  - Connect the antennae to the antenna inputs 17 of the first receiver.
  - Connect the antenna inputs 17 of the second receiver to the antenna outputs 18 of the first receiver and the antenna inputs 17 of the third receiver to the antenna outputs 18 of the second receiver etc.
  - Use the WA-CKL connecting cables.
  - Please turn on all receivers, so that they can be supplied with the antenna signal.
- For large multi-channel systems we recommend using one or more WA-AS 6 antenna splitters.

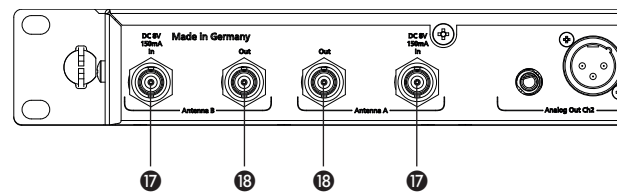

### 3. Chameleon Software

Each TG 1000 receiver is provided with an integrated web server with an own web page. In order to configure and monitor your TG 1000 receivers you need not install any software. You only need a network connection and an network-compatible device (client) with web browser. Therefore, you can control your TG 1000 system with a PC, Mac, tablet PC or smartphone.

If you use the Internet Explorer from Microsoft, make sure that it is version 8 or higher.

For a smooth operation of the Chameleon software your TG 1000 receivers must correctly be connected to a network. Then they can be operated in the manual or DHCP mode (default). With the manual mode you must manually assign each connected receiver a different IP address in the sub menu "Functions -> Network". With the DHCP mode the IP address is assigned by the so-called DHCP server, which is integrated in each standard router. If the DHCP mode is not used, a usual Ethernet switch will do for networking. In this case the receivers must be operated in the manual mode. In this network, without a DHCP server the client device also must receive a static IP address.

In order to use the Chameleon software with the client device, it can be linked to any TG 1000 receiver. For this you have to enter the IP address of the receiver in your web browser (e.g. "192.168.1.101"). The IP address of the receiver can be found in the sub menu "Functions -> Network". You can connect to any receiver. After a successful transmission of the web page the basic screen of the Chameleon software is displayed in the browser window. An overall view of all receivers in a virtual rack is displayed. The sequence of the displayed receivers is determined by the device ID, which can be selected in the sub menu "Functions -> Network" of the receiver. In order to ensure a clear assignment, you must assign each receiver a different device ID. The Chameleon Software displays an error message when there are two of the same Device IDs in the network. The receivers are displayed in an ascending order.

#### Message Log

- Select the "Message log" button to display error messages. If you want to delete these messages, select the "Clear log" button.

#### Move to Bottom / Top

- Select the "Move to Bottom" or "Move to Top" button to change the position of the display field.

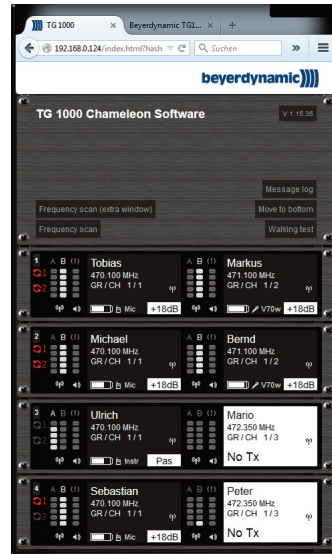

Chameleon-Software - Start screen

**Frequency Scan**

- The frequency selection in a particular frequency range can be made via the frequency scan. In this way you can also find out if there are interferences or not with individual frequencies.
- Select the “Frequency Scan” button.
- Select the resolution of the scan by selecting the measurement distances of 100 kHz, 200 kHz or 500 kHz.
- Enter the start frequency and stop frequency of the range within which it is to be scanned.
- Select the channel for which the scan is to be made. Due to the scanning process the selected channel is occupied while the other channel can still receive audio signals. Before the channel designation CH 1 or CH 2 you will find the appropriate Device ID. **Note:** If there is a TG 1000 transmitter active on one channel, this one cannot be used for a scan.
- Select the “Start” button.
- A scanning message will be displayed.

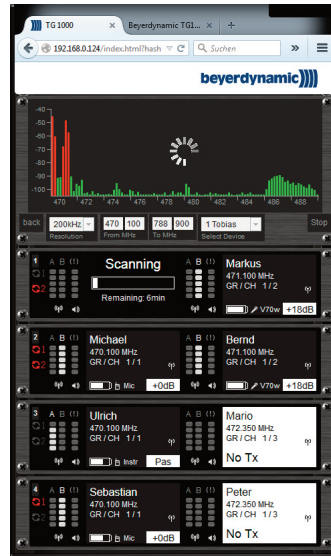

Chameleon-Software - “Frequency Scan”

- The scan displays the RF signals of the selected frequency range. These signals can be microphone signals or interferences caused by DVB-T channels. The Frequency Scan can be opened in an extra window by selecting the “Frequency scan (extra window)” button. This allows a larger view.

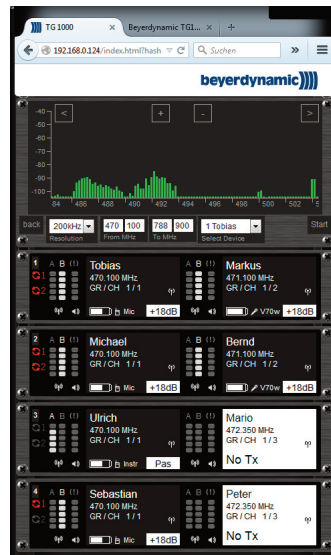

Chameleon-Software - Display of RF signals

**Walking Test**

- The “Walking Test” function is used to find out, using a portable device, where there are problems with the reception on a stage. Furthermore, it is also possible to recognise problems with the antennas.
- Select the “Walking Test” button.
- Select the channel under “Select Device”.
- Select the “Start” button. Both antenna signals are displayed over the time. Places where dead spots occur are indicated by a lower signal strength.
- The strip in the middle is the so-called diversity information which indicates the currently active antenna.

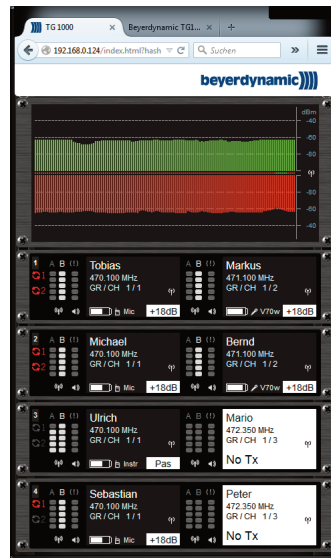

Chameleon-Software - “Walking Test”

**Receiver Settings**

- With the “Chameleon” software you can change the receiver settings. The changes are applied directly in the device. Furthermore, all status messages are also displayed on the receiver itself. The Sync LED lights up red when the transmitter and receiver have to be synchronised again.

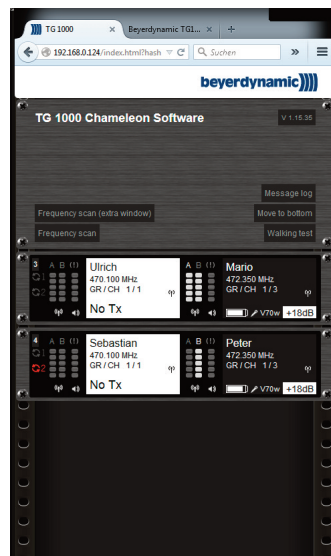

Chameleon-Software - Settings of receivers

- Select the channel window of the receiver to enter the channel menu.
- You can enter the following settings:
  - Name: You can enter the artist's name.
  - RF Power: You can set the transmitter power.
  - Battery: You can select if an alkaline or rechargeable NiMH battery has been inserted in the transmitter.
  - Encryp: You can enable or disable the encryption.
  - Power Lock: You can enable or disable the Power Lock function of the transmitter.
  - Freq MHz: You can enter a frequency manually.
  - Group / Channel: You can select a channel within the selected group stored in the receiver.
  - Handheld Gain: Menu setting "Handheld". Refer also to chapter 2.7 "Menu Settings".
  - Beltpack Gain: Menu setting "Beltpack". Refer also to chapter 2.7 "Menu Settings".
- You will find detailed descriptions of each setting in chapter 2.7 "Menu Settings".
- Select the "Back to Front" button to return to the front view of the receiver.



Chameleon-Software - Settings of receivers

### Device-specific View

- If you click on the Device ID of the receiver, you will receive more information such as IP address, Device ID, firmware of receiver controller and DSP, transmitter firmware (when transmitter is active).
- On the right hand side there is a selection dialogue to load user groups into the receiver.
- Select a file to select the "User Group".
- Select the "Submit" button to send the selected user group to the receiver.

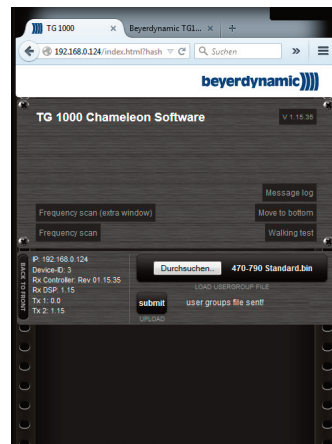

Chameleon-Software - Device-specific view

### Restricted Access

- For safety reasons there is a restricted access, so that only one client can be connected to the software.
- If another client tries to connect to the software, an error message will be displayed.

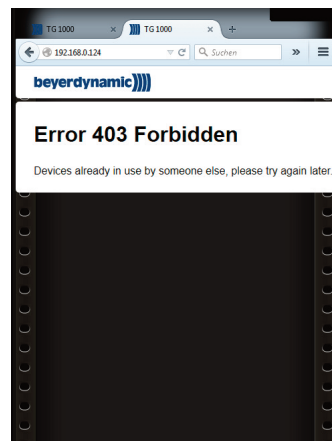

Chameleon-Software - access restriction

## 4. WA-AS 6/2 Antenna Splitter

### 4.1 Controls and Indicators

#### Front View



#### Rear View

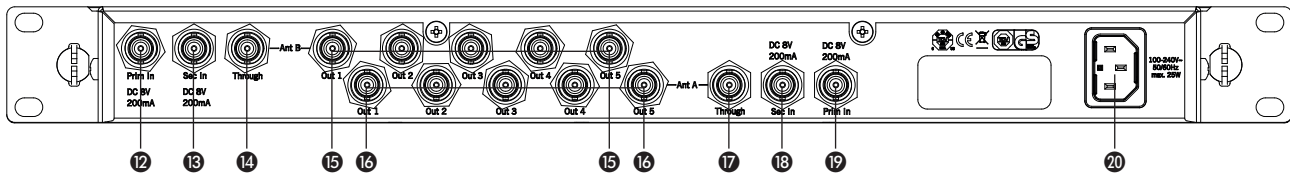

- |   |   |
|---|---|
| <ul style="list-style-type: none"> <li>❶ Hole for 19" rack mounting</li> <li>❷ Antenna input for front mounting of the antennae, BNC</li> <li>❸ On/off switch</li> <li>❹ Status LED antenna input A "Prim In" to indicate current output within the permitted range</li> <li>❺ Status LED antenna input A "Sec In" to indicate current output within the permitted range</li> <li>❻ Status LED antenna input A "Sec In" to indicate current output above the permitted range</li> <li>❼ Status LED antenna input A "Prim In" to indicate current output above the permitted range</li> <li>❽ Status LED antenna input B "Prim In" to indicate current output within the permitted range</li> <li>❾ Status LED antenna input B "Sec In" to indicate current output within the permitted range</li> </ul> | <ul style="list-style-type: none"> <li>❿ Status LED antenna input B "Sec In" to indicate current output above the permitted range</li> <li>⓫ Status LED antenna input B "Prim In" to indicate current output above the permitted range</li> <li>⓬ Antenna input B "Prim In", 8 V DC, 200 mA</li> <li>⓭ Antenna input B "Sec In", 8 V DC, 200 mA</li> <li>⓮ Antenna output B "Through" to loop-through the signal to further splitters</li> <li>⓯ Antenna outputs B</li> <li>⓰ Antenna outputs A</li> <li>⓱ Antenna output A "Through" to loop the signal through to further splitters or a receiver</li> <li>⓲ Antenna input A "Sec In", 8 V DC, 200 mA</li> <li>⓳ Antenna input A "Prim In", 8 V DC, 200 mA</li> <li>⓴ Mains connection</li> </ul> |
|---|---|

### 4.2 General Information

- The WA-AS 6/2 antenna splitter is a 6-way wideband antenna splitter operating in the frequency range of 470 to 832 MHz.
- With one WA-AS 6/2 antenna splitter you can operate up to 36 TG 1000 diversity receivers (cascaded) with only two antennae.
- For the diversity operation the WA-AS 6/2 is provided with two antenna inputs per antenna path and six outputs, one of them is optimised for looping through to other splitters. The operation is possible with antennae that are directly or remotely connected.
- Both antenna inputs provide a supply voltage for active antennae or antenna amplifiers.
- LEDs on the front display the status of the supply. The white "OK" LED (❹, ❺, ❽, ❾) means current output in the permitted range. The red "Ovl" LED (❻, ❼, ❿, ⓫) means current output above the permitted limit of 200 mA.

### 4.3 Mounting and Installation

- For the installation into a 19" rack the WA-AS 6/2 antenna splitter is provided with 19" holes ❶
- The split antenna outputs are connected to the antenna inputs of the receivers via the supplied BNC patch cables. In order to ensure the diversity operation, each receiver must be supplied with an A and a B antenna signal!
- Connect the WA-ATDA directional antenna or the WA-ATO omnidirectional antenna to the antenna inputs A and B "Prim In" (❷, ❸) or "Sec In" (❹, ❺). The antenna does not need a separate supply. It is directly supplied via the antenna input. For each antenna input, a maximum of 200 mA is available for the antenna supply.
- There is no separate on/off switch for supplying antenna amplifiers such as the WA-AMP2. The antenna amplifiers are supplied via the inputs. If the antenna supply of 200 mA available at the antenna input is exceeded, e.g. when using several active antennas/amplifiers, the WA-AMP2 antenna amplifier can be powered with an optional power supply unit.
- Connect the antenna splitter with the supplied power cable to an appropriate mains socket via the mains connection ❻. Switch on the antenna splitter with the on/off switch ❸.

### Important notes

- The antenna connections have a DC voltage of 8 V DC. In order to avoid a short circuit, they should not touch the housing of the rack.
- For the connection of remote antennae use the WA-AC antenna cable from beyerdynamic. The longer the cable, the higher the attenuation of the high frequency signal.
- The connected antennae and the antenna splitter must have the same frequency range of 470 – 832 MHz.
- By cascading several TG 1000 diversity receivers you can create larger multi-channel systems by using the antenna splitter.

### Example for application

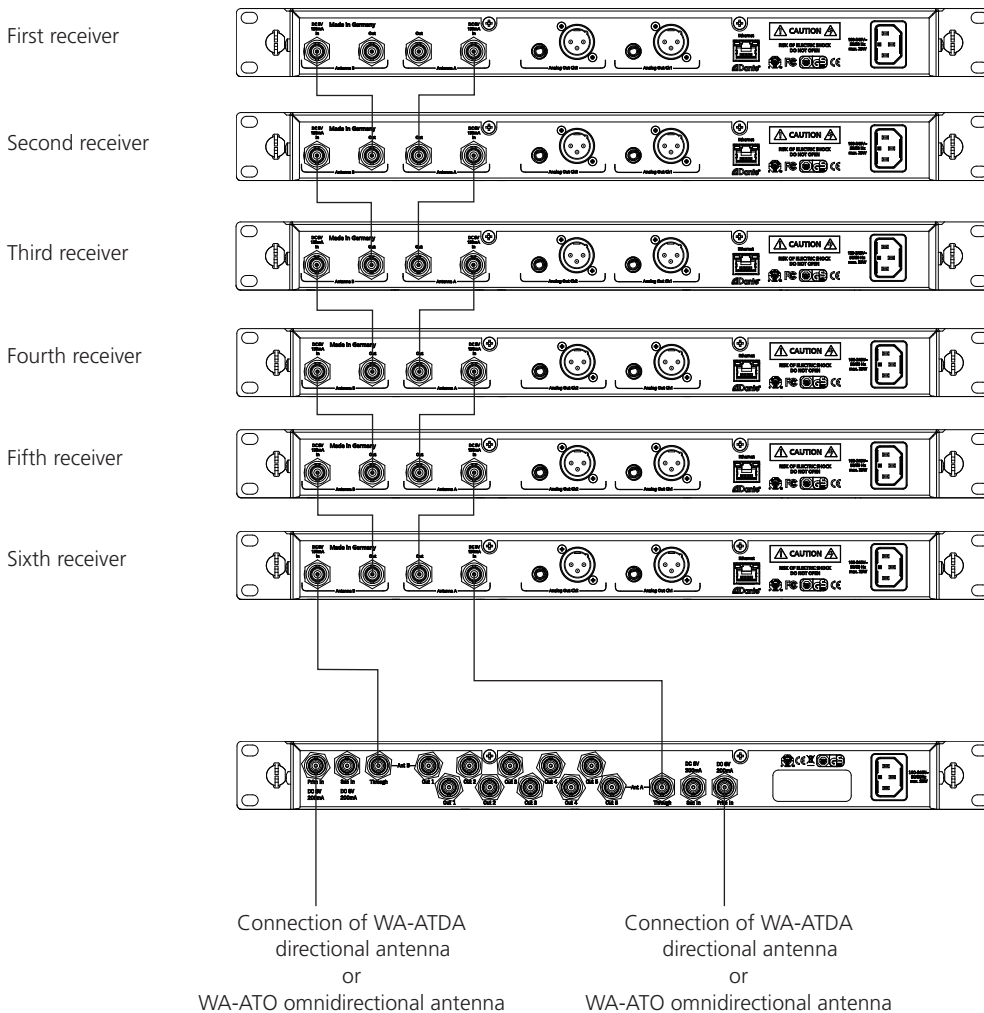

## 5. Digital TG 1000 UHF Handheld Transmitter

### 5.1 Controls and Indicators

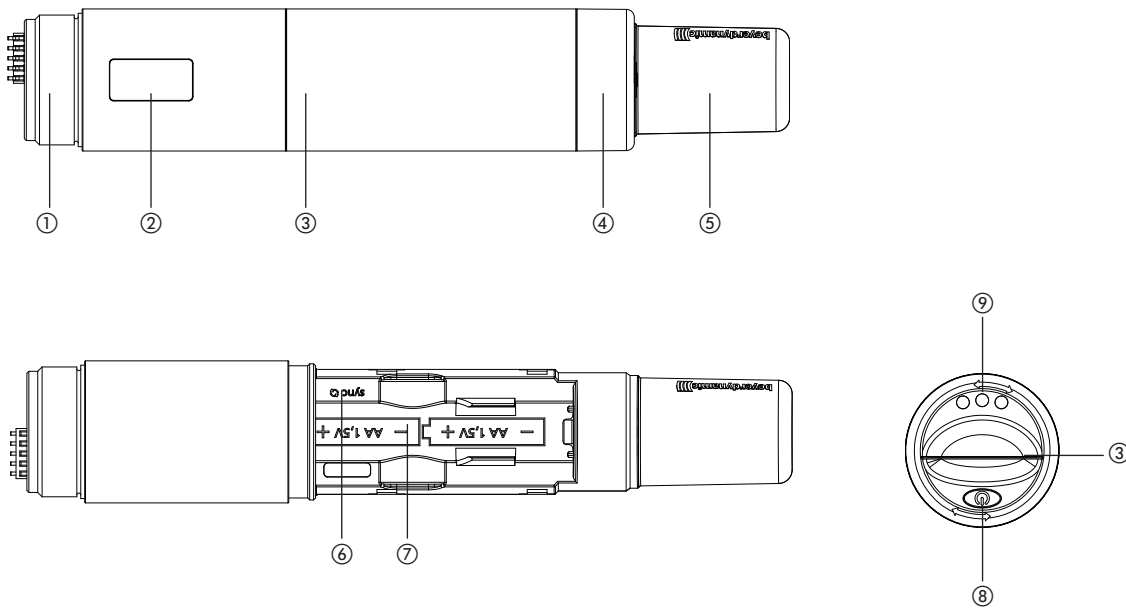

- ① Thread to attach a microphone head or adapter for microphone heads with a 1.25"/28 thread from other manufacturers
- ② OLED display
- ③ Cover for battery compartment
- ④ Coloured ring, replaceable
- ⑤ Antenna
- ⑥ Infrared interface für synchronisation
- ⑦ Battery compartment
- ⑧ On-off button
- ⑨ Charging contacts



## 5.2 How to Attach the Microphone Head

For the TG 1000 handheld transmitter there are different condenser and dynamic microphone capsules or the WA-HHA-SHBY adapter available to connect microphone heads with a 1.25"/28 thread from other manufacturers. Refer also to "Optional Accessories".

- Put the requested microphone head or the WA-HHA-SHBY adapter onto the thread of the handheld transmitter ① and tighten it clockwise.
- If you want to change the microphone head, unscrew it from the transmitter by turning it anti-clockwise.
- Make sure that you **switch off** the handheld transmitter **before** changing the microphone head.

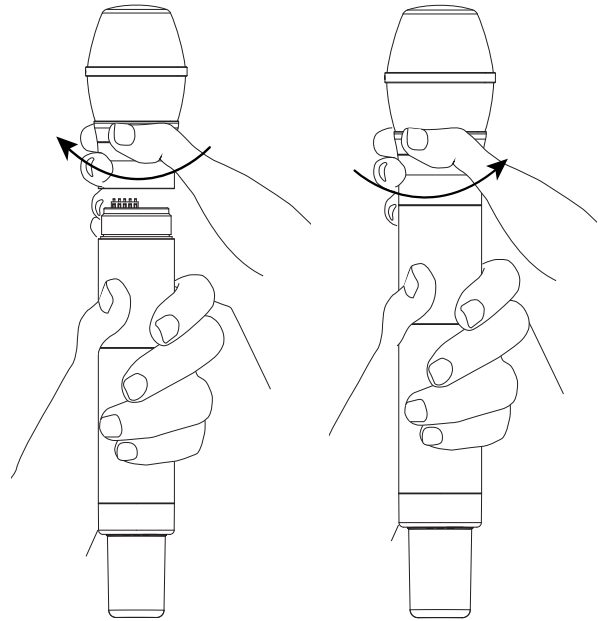

Tighten the microphone head clockwise.

Unscrew the microphone head by turning anti-clockwise.

### TG V50w

Dynamic microphone head, cardioid polar pattern, for vocals. Very wide pick-up area. High gain before feedback.

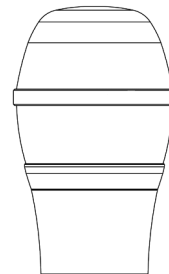

### TG V56w

Condenser microphone head, cardioid polar pattern, for solo singers, conference and speeches. Discreet treble boost. High gain before feedback.

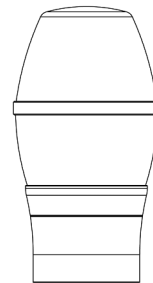

### TG V70w

Dynamic microphone head, hypercardioid polar pattern, for vocals. Powerful sound. Extremely high gain before feedback.

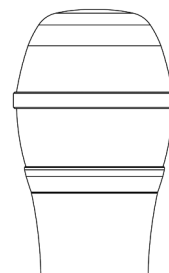

**TG V90w**

Dynamic ribbon microphone head, cardioid polar pattern, for vocals. Clear, natural sound. High gain before feedback.

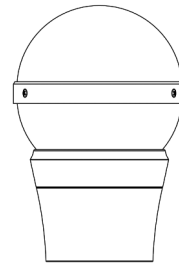

**TG V96w**

Condenser microphone head, cardioid polar pattern, for vocals. Uncoloured reproduction. Discreet treble boost for an open and unobtrusive sound. High gain before feedback.

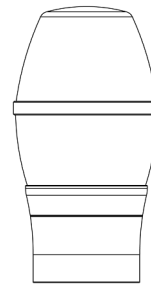

**TG MM1w**

Measurement microphone head, omnidirectional polar pattern, for wireless measuring of sound reinforcement systems. Calibrated open circuit voltage. Slim and robust fully metal housing.

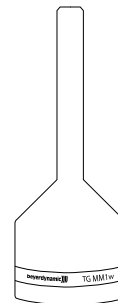

**WA-HHA-SHBY**

Aluminium adapter with a 1.25"/28 thread for microphone capsules from: DPA®, Shure®, Heil Sound®, Sony®, Lectrosonics®, EV®, Blue®, Line6®, Earthworks®, Telefunken®. 7 V-powering for higher signal-to-noise ratio.



Connects to handheld transmitter

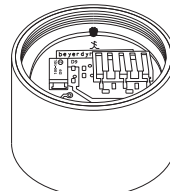

Connects to microphone capsule

### 5.3 How to Insert the Batteries

- Unscrew the cover of the battery compartment ③ as indicated by the arrows.
- Remove the cover of the battery compartment ③.

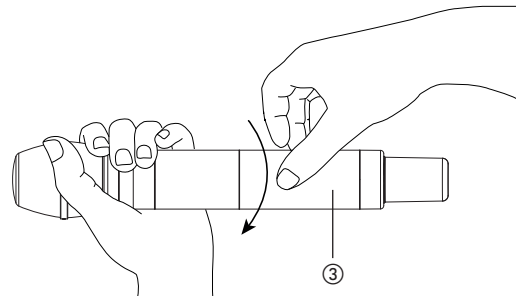

- Insert two alkaline batteries, AA 1.5 V or rechargeable NiMH batteries according to the symbols in the battery compartment ⑦.
- Slide the cover of the battery compartment ② upwards again and tighten it.

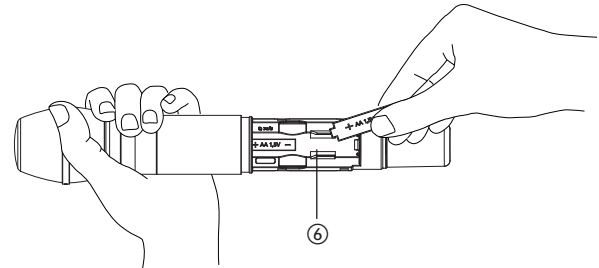

- The current battery status is shown in the display of the transmitter and receiver. Make sure that before the synchronisation the appropriate battery type has been selected in the channel menu.
- If the operating time of the batteries is approx. 30 to 40 minutes, in the display of the receiver the "Low Batt" symbol is flashing.
- When the batteries are empty, the transmitter displays an empty flashing battery symbol. In this case, you should replace the batteries as soon as possible with new ones.
- When you use NiMH rechargeable batteries for operation, you can recharge them with the optional WA-CD charger. During the charging process the batteries can remain inside the transmitter. For further information, please refer to the separate WA-CD manual.
- **Important:** From time to time the battery and charging contacts of the transmitter should be cleaned with a lint-free soft cloth moistened with spirits or alcohol. Please remove the batteries from the battery compartment before cleaning.

### 5.4 How to Operate the Handheld Transmitter

- Turn on the handheld transmitter by holding the on-off button ⑧ pressed, until the standard display is shown in the display ⑦.
- The display ⑦ shows the battery status and the name, which has been entered in the first line of the receiver.
- In the second line, depending on the setting, you will see the channel and frequency group or the frequency. By pressing the on-off button ⑧ briefly several times you can display further information in the second line.  
Further information are: RF power, battery, microphone head and status of encryption and power lock.
- When you hold the on-off button ⑧ pressed while turning on, you can display the region code and version number.
- Make sure that transmitter and receiver operate on the same frequency.
- The handheld transmitter features a high dynamic range. This is the reason why it does not have a switch to set the level. With low signals the audio level can be increased by increasing the "Digital Gain" on the receiver. Refer also to chapter 2.7 "Menu Settings", "Digital Gain".
- To turn off the transmitter hold the on-off button ⑧ pressed until the message "Off" is displayed.
- If the "Power Lock" function is activated you can nevertheless turn off the handheld transmitter. Press the on-off button ⑧ until the "Power Locked" message is displayed ⑦. Release the button and press the button until the "Off" message will be displayed. Then the handheld transmitter is turned off.
- The transmitter is supplied with a black ring ④. When using several transmitters, each transmitter can be equipped with a different coloured ring for a better differentiation. Pull off the ring and attach the requested coloured ring so that it clicks into place.
- If you want to change into the "RF off" mode, press the on-off button ⑧ of the handheld transmitter until the message "RF off" is displayed. Now you can, for example, synchronise a spare transmitter on the same channel, although the main transmitter is still active (audio continues to function when synchronising).
- Perform the synchronisation for the spare transmitter.
- To exit the "RF off" mode turn the transmitter off and on again.

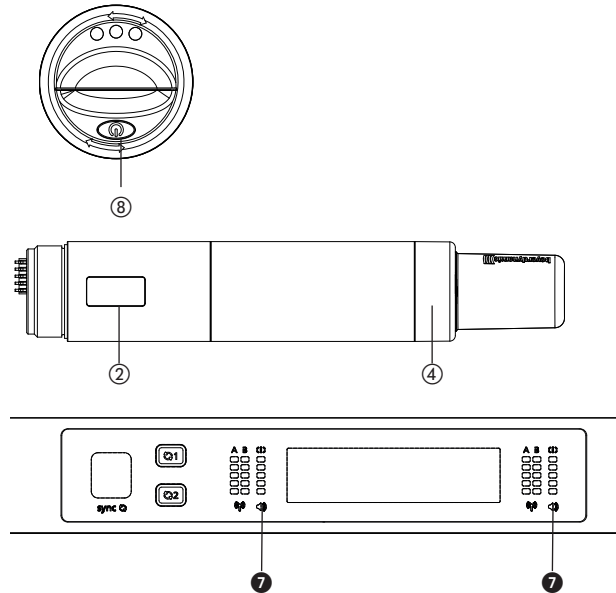

### 5.5 Synchronisation / How to Transmit the Receiving Frequency to the Transmitter

- In order to transmit the frequency and other settings to the transmitter, press the button for synchronisation ⑤ on the receiver for channel 1 or channel 2.
- In the battery compartment of the transmitter there is an infrared interface.
- During the synchronisation hold the infrared interface ⑤ in the open battery compartment of the **turned on** transmitter directly in front of the infrared interface ④ on the receiver.
- When the message "SYNC successful" is displayed, the process is finished.

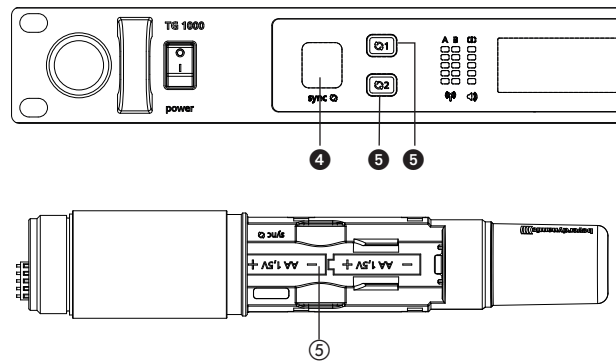

## 5.6 Maintenance

- Protect the handheld transmitter from humidity, knocks and shock. Avoid dropping the transmitter at all times.
- For cleaning metal surfaces, use a soft cloth moistened with methylated spirits or alcohol.
- As soon as your microphone sounds dull, you should clean the integrated pop shield. Proceed as described in the following.
  - Unscrew the microphone grille anti-clockwise.
  - Pull out the foam pop shield, if necessary use tweezers and clean it under clear running water.
  - If necessary, use a mild washing-up liquid.
  - Dry it afterwards with a hairdryer or allow it to dry overnight.
  - Clean the microphone grille both inside and out with a slightly moistened cloth or a soft brush under clear running water and allow it to dry overnight.
  - The microphone grille **cannot** be cleaned in a dishwasher.
  - Place the dry pop shield inside the microphone grille and replace the microphone grille by screwing it on clockwise.

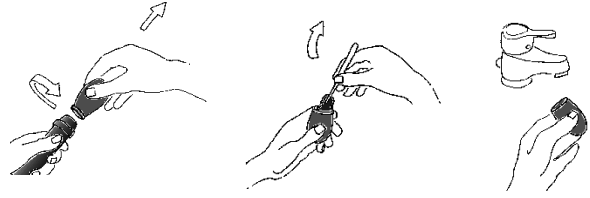

- With the **TG V90w** loosen the screws with a small screwdriver and turn the upper part of the microphone head anti-clockwise to unscrew it.
- Clean the upper grille under clear running water.
- Allow the upper grille to dry overnight before you replace it.
- The upper grille **cannot** be cleaned in a dishwasher.

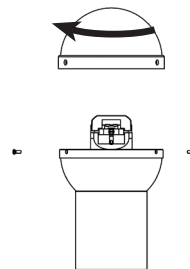

TG V90w

- The **TG V96w** is provided with a mesh pop shield.
- For cleaning turn the microphone grille anti-clockwise to unscrew.
- Turn the wire mesh pop shield anti-clockwise to unscrew.
- Clean the pop shield under clear running water.
- Allow the pop shield to dry overnight before you replace it.
- The wire mesh pop shield **cannot** be cleaned in a dishwasher.
- Clean the microphone grille inside and outside with a slightly moistened cloth or a soft brush under clear running water and allow it to dry overnight.
- The microphone grille **cannot** be cleaned in a dishwasher.

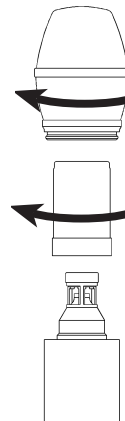

TG V96w

## 6. Digital TG 1000 UHF Beltpack Transmitter

### 6.1 Controls and Indicators

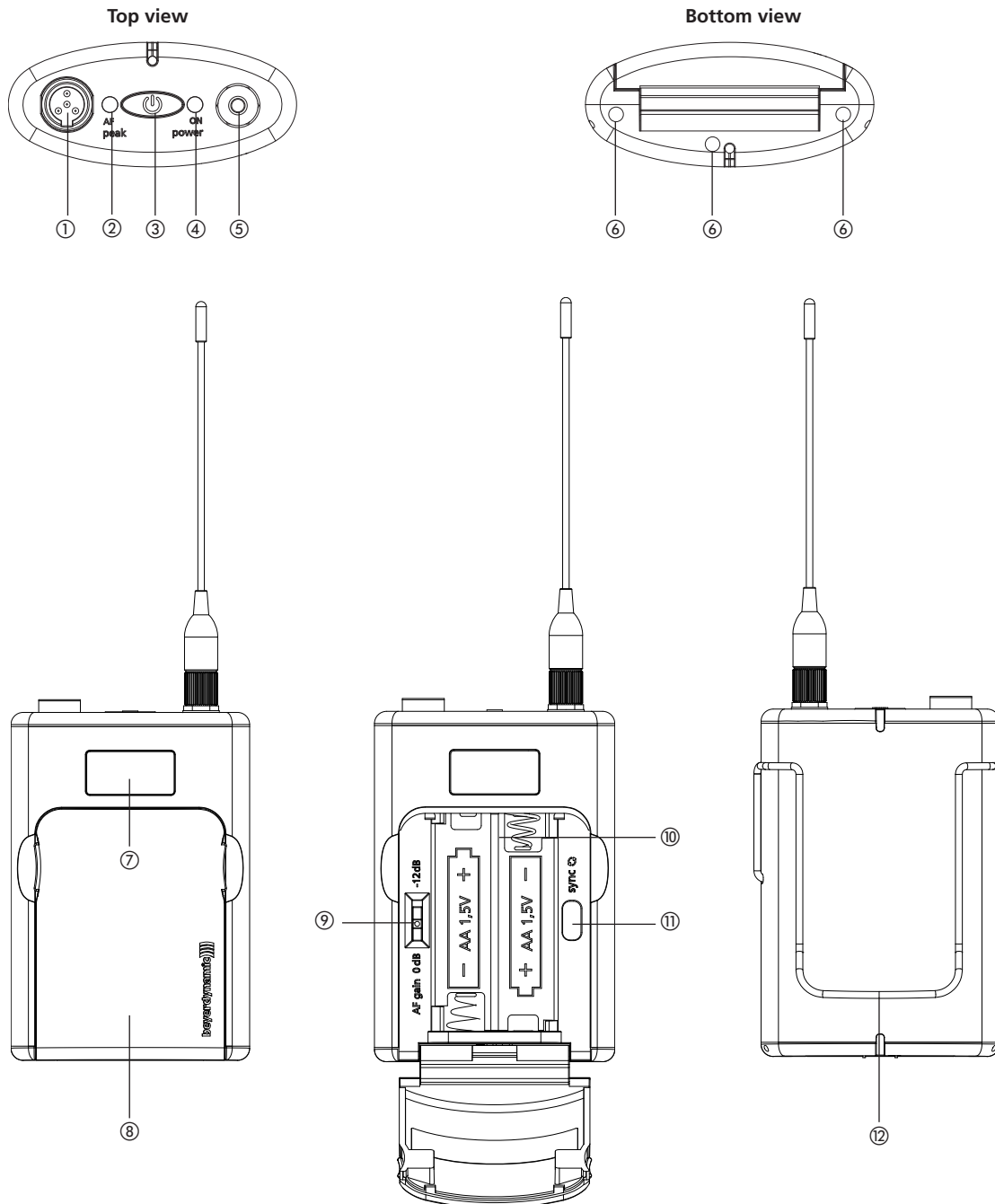

- ① 4-pin mini XLR connector (male) to connect microphones or instruments
- ② AF peak LED
- ③ On-off button
- ④ Power on LED
- ⑤ Antenna connector, SMA socket
- ⑥ Charging contacts

- ⑦ OLED display
- ⑧ Cover of the battery compartment
- ⑨ Gain switch 0 dB / -12 dB
- ⑩ Battery compartment
- ⑪ Infrared interface for synchronisation
- ⑫ Belt clip

## 6.2 How to Insert the Batteries

- Take hold of the cover of the battery compartment ⑧ on top at the inlets at the right and left hand side.
- Flap the cover of the battery compartment ⑧ downwards.
- Insert two alkaline batteries, AA 1.5 V or rechargeable NiMH batteries according to the symbols in the battery compartment ⑩. Make sure that before the synchronisation the appropriate battery type has been selected in the channel menu.
- Flap the cover of the battery compartment ⑧ upwards to close. Magnets ensure a secure fastening.
- The current battery status is shown in the display of the transmitter and receiver.
- If the operating time of the batteries is approx. 30 to 40 minutes, in the display of the receiver the “Low Batt” symbol is flashing.
- When you use NiMH rechargeable batteries for operation, you can recharge them with the optional WA-CD charger. During the charging process the batteries can remain inside the transmitter. For further information, please refer to the separate WA-CD manual.
- **Important:** From time to time the battery and charging contacts of the transmitter should be cleaned with a lint-free soft cloth moistened with spirits or alcohol. Please remove the batteries from the battery compartment before cleaning.

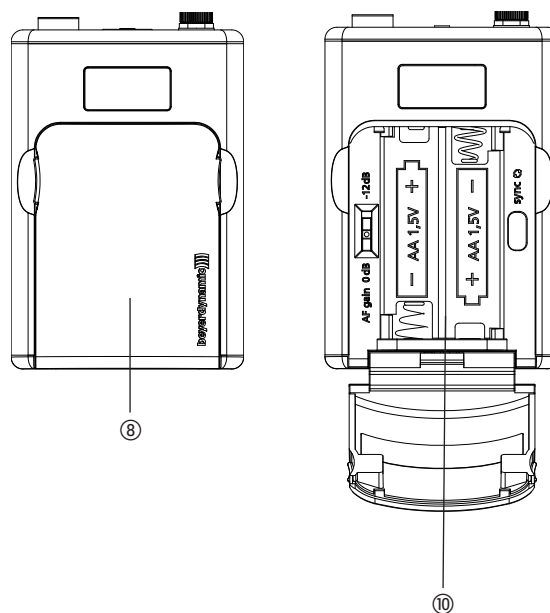

## 6.3 How to Operate the Beltpack Transmitter

- Connect a microphone or the WA-CGI instrument cable to the 4-pin mini XLR connector ①.
- Connect the supplied antenna with SMA connector to the antenna connector ⑤.
- Turn on the beltpack transmitter by holding the on-off button ③ pressed, until the standard display is shown in the display ⑦. The Power on LED ④ will illuminate green.
- The display ⑦ shows the battery status and the name, which has been entered in the first line of the receiver.
- On the second line, depending on the setting, you will see the channel and frequency group or the frequency. By pressing the on-off button ③ briefly several times you can display further information on the second line.  
Further information are: RF power, battery, microphone head and status of encryption and power lock.
- When you hold the on-off button ③ pressed while turning on, you can display the region code and version number.
- Make sure that transmitter and receiver operate on the same frequency.
- To turn off the transmitter hold the on-off button ③ pressed until the message “Off” is displayed.
- If the “Power Lock” function is activated you can nevertheless turn off the beltpack transmitter. Press the on-off button ③ until the “Power Locked” message is displayed ⑦. Release the button and press the button until the “Off” message will be displayed. Then the handheld transmitter is turned off.
- If you want to change into the “RF off” mode, press the on-off button ③ of the handheld transmitter until the message “RF off” is displayed. Now you can, for example, synchronise a spare transmitter on the same channel, although the main transmitter is still active (audio continues to function when synchronising).
- Perform the synchronisation for the spare transmitter.
- To exit the “RF off” mode turn the transmitter off and on again.

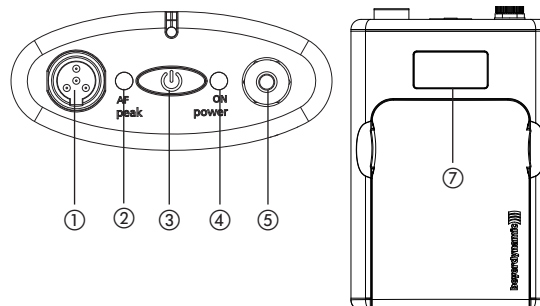

### 6.4 Synchronisation / How to Transmit the Receiving Frequency to the Transmitter

- In order to transmit the frequency and other settings to the transmitter, press the button for synchronisation ⑤ on the receiver for channel 1 or channel 2.
- In the battery compartment of the transmitter there is an infrared interface ⑩.
- During the synchronisation hold the infrared interface ⑩ in the open battery compartment of the **turned on** transmitter directly in front of the infrared interface ④ on the receiver.
- When the message “SYNC successful” is displayed, the process is finished.

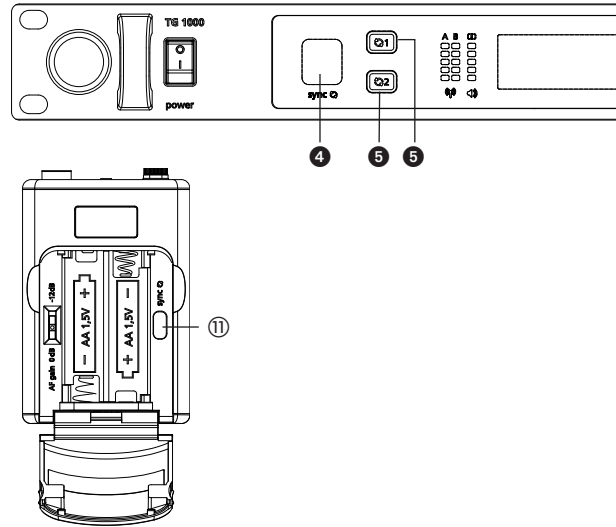

### 6.5 How to Use the Gain Switch

- The beltpack transmitter has a switchable pre-attenuation of -12 dB, so that sources with an extremely high signal level can be connected by using the instrument cable (e.g. electric guitars or basses with active pick-ups). In this case set the gain switch ⑨ to -12 dB. We recommend to select the channel parameter “Instr Act 0 dB” in the “Beltpack” menu item of the receiver.
- If you connect an electret microphone to the microphone input ① of the transmitter, you must set the gain switch ⑨ to 0 dB. If distortions occur at very loud signals, you need a microphone with a low sensitivity, because the distortions already arise inside the microphone.
- With quiet signals, the audio level can be increased by increasing the “Beltpack Gain” on the receiver. See also chapter 2.7 “Settings menu” the “Beltpack Gain” paragraph.

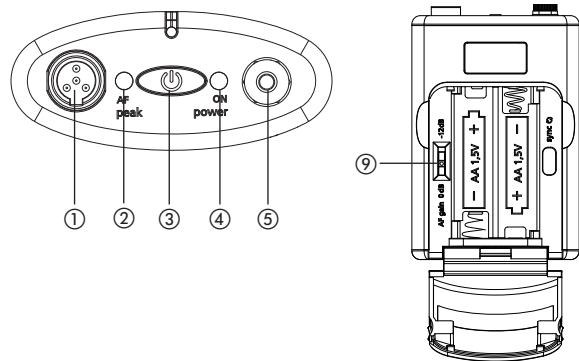

### 6.6 How to Mount the Belt Clip

- The beltpack transmitter is supplied with two belt clip to attach the transmitter to clothes, belts, a guitar strap etc.
- You can remove the belt clip by pulling it from the fixation of the beltpack transmitter.
- The belt clips can be mounted vertically or horizontally.  
 Vertical: to attach the transmitter to clothes or a belt  
 Horizontal: to attach the transmitter to a guitar strap

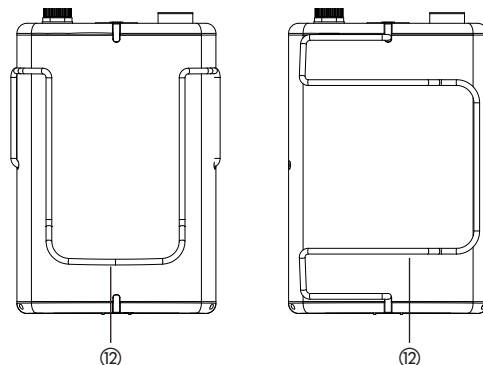



## 7. General Instructions for all Transmitters

- Check the transmitter battery and replace or recharge it if necessary. Use fresh alkaline batteries only or recharge the rechargeable batteries.
- Switch off the transmitter before changing the batteries.
- If the transmitter is not being used for weeks or months, please remove the batteries. Batteries can leak when not being used for a long time and corrode the conductor strips and components. Repair is not then possible. In this case all warranty claims are null and void. The description “leak proof” on batteries is no guarantee that they will not run out.
- From time to time the battery contacts should be cleaned with a soft cloth moistened with spirits or alcohol.
- Do not throw used batteries into the domestic rubbish, but hand them in to local collection points.
- For charging rechargeable batteries use standard battery chargers.

## 8. Comments on the Audio Level

In the development of TG 1000 it was the objective to create a system that transmits audio as accurately as possible, that has a clear level and is as simple as possible to handle.

In order to cover all relevant practical applications with a wide dynamic range, there are several ways to adjust the audio levels.

### Level settings on the transmitter

The TG 1000 system does without the possibility of setting the level on the transmitters, except the sensitivity switch on the beltack transmitter. In return, the analogue-digital conversion, and the CODEC used with a very high dynamic range are performed. If required or desired, this concept makes it possible to comfortably adjust the volume on the receiver without having to synchronise the transmitter or to make new settings.

### Gain switch of the beltack transmitter:

This switch allows setting a passive attenuation of -12dB. This is required if sources with an extremely high signal level (e.g. electric guitars or basses with active pick-ups) are to be connected.

For electret microphones the setting of 0 dB must be used. Should distortions still occur at very loud signals, the use of microphones with a lower sensitivity is required, as in this case, the distortion arises in the microphone itself. The output level of the electret microphone can not be higher than the supply voltage, which is provided by the beltack transmitter, and this level can smoothly be processed even in the 0 dB position. The -12dB attenuation would indeed reduce the level, but not prevent the distortion.

### Level settings on the receiver

The output volume can be set between 0 and +42 dB for the hand-held transmitter (menu item “Handheld Gain”) and beltack transmitter (menu item “Beltack Gain”) on the receiver front via the rotary switch.

“Handheld Gain” adjustable range: 0 to +42 dB

“Beltack Gain” adjustable range: Instrument Active 0dB  
Instrument Passive 0dB  
Mic 0 to +42 dB

### Amplification by the entire system

If the “Instrument passive” function is selected in the “Beltack Gain” menu item and the passive pre-attenuation in the beltack transmitter is not used, the output level exactly corresponds to the input level.

With active instruments you should use the passive pre-attenuation inside the beltack transmitter.

If the “Instrument Active” function is selected in the “Beltack Gain” menu item, a 0 dB structure is produced again.

Block Diagrams

Audio Level of Beltpack Transmitter

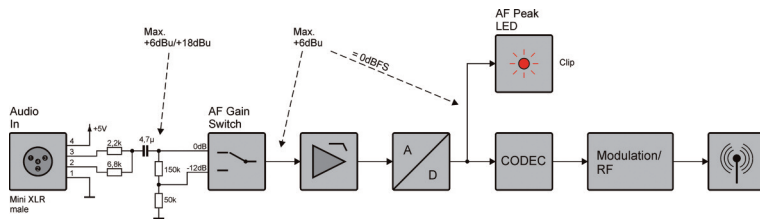

Audio Level of Handheld Transmitter

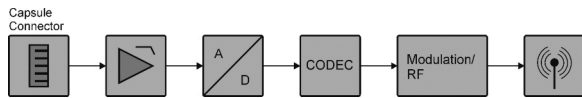

Audio Level of Receiver

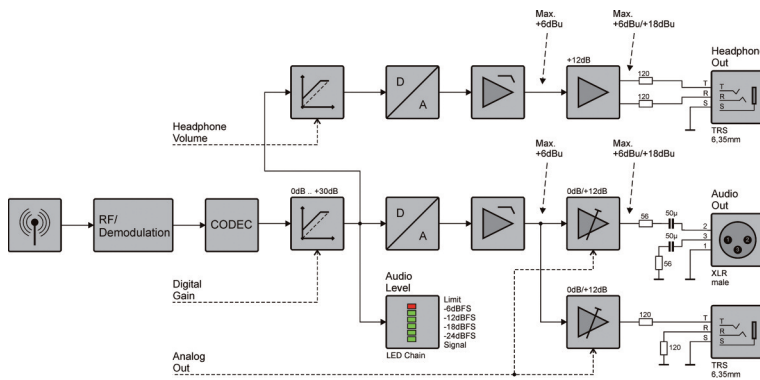

## 9. Components

### Digital UHF Diversity Receiver

Region A	Two-channel true diversity receiver, 470 - 789 MHz	Order # 708.984
Region B	Two-channel true diversity receiver, 470 - 698 MHz (without 608 - 614 MHz (US TV channel 37))	Order # 709.123
Region C	Two-channel true diversity receiver, 520 - 694 MHz	Order # 709.131
Region D	Two-channel true diversity receiver, 470 - 638 MHz & 650 - 758 MHz	Order # 711.381
Region E	Two-channel true diversity receiver, 470 - 714 MHz	Order # 709.158

### Digital UHF Handheld Transmitter

Region A	Handheld transmitter for TG 1000 receiver, 470 - 789 MHz	Order # 711.039
Region B	Handheld transmitter for TG 1000 receiver, 470 - 698 MHz (without 608 - 614 MHz / US TV channel 37)	Order # 711.047
Region C	Handheld transmitter for TG 1000 receiver, 520 - 694 MHz	Order # 711.055
Region D	Handheld transmitter for TG 1000 receiver, 470 - 638 MHz & 650 - 758 MHz	Order # 711.063
Region E	Handheld transmitter for TG 1000 receiver, 470 - 714 MHz	Order # 711.071

### Digital UHF Beltpack Transmitter

Region A	Beltpack transmitter for TG 1000 receiver, 470 - 789 MHz	Order # 711.942
Region B	Beltpack transmitter for TG 1000 receiver, 470 - 698 MHz (without 608 - 614 MHz / US TV channel 37)	Order # 711.950
Region C	Beltpack transmitter for TG 1000 receiver, 520 - 694 MHz	Order # 711.969
Region D	Beltpack transmitter for TG 1000 receiver, 470 - 638 MHz & 650 - 758 MHz	Order # 711.977
Region E	Beltpack transmitter for TG 1000 receiver, 470 - 714 MHz	Order # 711.985

## 10. Accessories

### Supplied Accessories

#### Digital UHF Diversity Receiver

Power cable	
Quick Start Guide	
2 x WA-ATS standard omnidirectional antennae	
1 x WA-ADF Connecting cable to mount the antennas on the front	Order # 712.795
1 x WA-CKL60 Connecting cable set with two cables to cascade TG 1000 receivers	Order # 712.809

### Optional

#### Digital UHF Diversity Receiver

##### Antenna Splitter/Combiner

WA-AS6/2	6-way wideband antenna splitter / 2-way antenna combiner for wireless systems with BNC connection, antenna supply 8V DC, 470 - 832 MHz	Order # 711.160
WA-ZAPD1	Passive 2-way combiner with BNC connections, 470 - 790 MHz	Order # 711.217

##### Antennae

WA-ATDA	Passive/active wideband directional antenna for wireless systems with BNC connection, 470 - 790 MHz	Order # 711.004
WA-ATO	Wideband omnidirectional antenna for wireless systems with BNC connection, 470 - 790 MHz	Order # 711.586

##### Cables

WA-AC25	BNC antenna cable, length 25 metres, low-attenuation Aircell 7 cable	Order # 711.578
WA-AC10	BNC antenna cable, length 10 metres, low-attenuation Aircell 7 cable	Order # 711.551
WA-AC5	BNC antenna cable, length 5 metres, low-attenuation Aircell 7 cable	Order # 711.543
WA-CGI	Connecting cable to connect instruments with a mono 1/4" jack plug	Order # 711.608

##### Amplifier

WA-AMP2	Wideband antenna amplifier for wireless systems with BNC connection switchable amplification of 5 dB / 10 dB / 15 dB, 470 - 1,000 MHz	Order # 712.035
WA-PSU 12/1	Power supply unit 12 V/1 A, 100 - 230 V, 50/60 Hz, for WA-AMP2	Order # 712.051

#### Digital UHF Handheld Transmitter

##### Interchangeable Microphone Capsules

TG MM1w	Measurement microphone head, electret condenser, omnidirectional	Order # 712.043
TG V50w	TG 1000 microphone capsule, dynamic, cardioid, incl. storage bag	Order # 711.438
TG V56w	TG 1000 microphone capsule, electret condenser, cardioid, incl. storage bag	Order # 711.446
TG V70w	TG 1000 microphone capsule, dynamic, hypercardioid, incl. storage bag	Order # 711.454
TG V90w	TG 1000 microphone capsule, ribbon, cardioid, incl. storage bag	Order # 711.462
TG V96w	TG 1000 microphone capsule, true condenser, cardioid, incl. storage bag	Order # 711.470

WA-HHA-SHBY	Adapter to attach microphone capsules from Shure®* or microphone capsules with a 1.25"/28 thread	Order # 711.012
-------------	--	-----------------

WA-MS	Coloured ring set consisting of 6 rings (black, red, yellow, green, white, blue)	Order # 711.152
-------	--	-----------------

\*Trademark Notice: Shure is a registered trademark of Shure Incorporated, USA

**Digital UHF Beltpack Transmitter****Microphones**

TG L58 (TG)	Miniature condenser clip-on microphone, omnidirectional, capsule diameter 6 mm, with 4-pin mini XLR connector, black . . . . .	Order # 706.221
TG L58 tan (TG)	same as above, but beige . . . . .	Order # 705.926
TG H56 (TG)	Miniature condenser headset microphone, omnidirectional, black, with 4-pin mini XLR connector . . . . .	Order # 705.888
TG H56 tan (TG)	same as above, but beige . . . . .	Order # 705.853
TG H74 (TG)	Neckworn microphone, condenser, cardioid, 4-pin mini XLR connector, black . . . . .	Order # 708.364
TG H74 tan (TG)	same as above, but beige . . . . .	Order # 708.372

**Charger**

WA-CD	Charger for TG 1000 Beltpack and TG 1000 Handheld transmitters as well as Quinta TH handheld transmitter, with 4 charging compartments and control via Ethernet; charges up to 2 handheld and 2 beltpack transmitters or 2 handheld transmitters and 4 NiMH rechargeable batteries simultaneously . . . . .	Order # 711.144
-------	---	-----------------

**11. Technical Specifications****Digital UHF Diversity Receiver**

Operating principle . . . . .	Digital UHF true diversity receiver
Frequency range	
Region A . . . . .	470 – 789 MHz
Region B . . . . .	470 – 698 MHz without 608 – 614 MHz (US TV channel 37)
Region C . . . . .	520 – 694 MHz
Region D . . . . .	470 - 638 MHz & 650 - 758 MHz
Region E . . . . .	470 – 714 MHz
Frequency response . . . . .	20 – 20,000 Hz
Dynamic range . . . . .	116 dB (128 dB with -12 dB level decrease in the beltpack transmitter)
Output level . . . . .	max. + 18 dBu balanced (XLR and jack output) 0 to 42 dB gain
Output impedance jack output . . . . .	120 $\Omega$
Antenna input . . . . .	8 V DC, 150 mA
Headphone output . . . . .	switchable with volume control
Latency . . . . .	2.1 ms (overall latency from transmitter to receiver)
Encryption & Audio CODEC . . . . .	Switchable, proprietary encryption scheme based upon a 16 bit pattern; "Triple-Play" CODEC with low latency and high error resilience
Display . . . . .	OLED
Mains connection . . . . .	100 V – 240 V AC
Power consumption . . . . .	13.8 W (typ.)
Ambient temperature . . . . .	0 to +55 °C
Weight . . . . .	3200 g
Dimensions . . . . .	420x242x43 mm
Antenna connection . . . . .	2 x BNC input/2 x BNC output
Network connection . . . . .	Ethernet / Dante, RJ45: 48 kHz, 96 kHz, 24 bit

**Digital UHF Handheld Transmitter**

Operating principle . . . . .	Digital UHF handheld transmitter
Frequency range	
Region A . . . . .	470 – 789 MHz
Region B . . . . .	470 – 698 MHz without 608 – 614 MHz (US TV channel 37)
Region C . . . . .	520 – 694 MHz
Region D . . . . .	470 - 638 MHz & 650 - 758 MHz
Region E . . . . .	470 – 714 MHz
Frequency response . . . . .	20 – 20,000 Hz
Encryption & Audio CODEC . . . . .	Switchable, proprietary encryption scheme based upon a 16 bit pattern; "Triple-Play" CODEC with low latency and high error resilience
Transmitter power . . . . .	10 mW/50 mW
Dynamic range . . . . .	116 dB (A-weighted)
Display . . . . .	OLED
Transmission range . . . . .	up to 300 metres under optimal conditions
Operating time . . . . .	approx. 8 hrs. (NiMH 2100 mAh, RF Power Standard)
Weight . . . . .	152 g without batteries and microphone capsule
Dimensions . . . . .	Length 200 mm / $\varnothing$ 36 mm

**Digital UHF Beltpack Transmitter**

Operating principle . . . . . Digital UHF beltpack transmitter

Frequency range

Region A . . . . . 470 – 789 MHz

Region B . . . . . 470 – 698 MHz without 608 - 614 MHz (US TV channel 37)

Region C . . . . . 520 – 694 MHz

Region D . . . . . 470 - 638 MHz & 650 - 758 MHz

Region E . . . . . 470 – 714 MHz

Frequency response . . . . . 20 – 20,000 Hz

Antenna connection . . . . . SMA

Encryption & Audio CODEC . . . . . Switchable, proprietary encryption scheme based upon a 16 bit pattern; “Triple-Play” CODEC with low latency and high error resilience

Transmitter power . . . . . 10mW / 50 mW

Dynamic range . . . . . 116 dB (A-weighted)

Display . . . . . OLED

Transmission range . . . . . up to 300 metres under optimal conditions

Operating time . . . . . approx. 8 hrs. (NiMH 2100 mAh, RF Power Standard)

Input level . . . . . max. + 18 dBu

Weight . . . . . 102 g without batteries

Dimensions . . . . . 94x59x26 mm

Pin assignment of 4-pin connector . . . . .

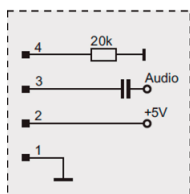

Pin assignment of 3-pin Lemo connector . . . . .

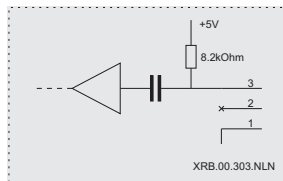

**WA-AS6/2 6-way Wideband Antenna Splitter/2-way Combiner**

Frequency response . . . . . 470 – 832 MHz

Connections . . . . . Input/output BNC socket

Antenna powering . . . . . 8 V DC, 200 mA per input

Mains connection . . . . . 100 V – 240 V AC

Power consumption . . . . . 6.5 W – 18.5 W

Weight . . . . . 2850 g

Dimensions . . . . . 420x242x44 mm

**WA-AMP2 Wideband Antenna Amplifier**

Frequency response . . . . . 470 – 1,000 MHz

RF connection . . . . . Input/output BNC socket

Wave impedance . . . . . 50 Ω

Input Intercept Point

third order (IIP3) . . . . . 22 dBm

Amplification switchable in 3 stages . . . . . 5 dB, +10 dB, +15 dB

Supply via antenna cable . . . . . 8 - 9 V DC, 75 mA

Supply via external power supply unit . . . . . 12 V DC, 350 mA

Operating temperature range . . . . . 0 °C to +45 °C

Dimensions (H x W x D) . . . . . 108 x 98 x 30 mm

Weight . . . . . 160 g

## 12. Service

In the unlikely event of equipment failure, the product should be returned to your beyerdynamic dealer. Unauthorised attempts at repair may invalidate the warranty.

## 13. Licensing

Before operating your radio microphone system or other audio transmission applications, ask the responsible supervisory authority for frequency utilisation for the exact frequency allocations and apply for any individual licence required.

**Important:**

Depending on the frequency range and region, wireless systems may require a broadcasting licence and may be subject to registration and fees.

For professional users in Germany, frequency ranges requiring registration are from 470 to 789 MHz.

It is the responsibility of the user to set suitable frequencies.

Current information about regulations regarding the operation of wireless systems in Germany can be found at: [www.bundesnetzagentur.de](http://www.bundesnetzagentur.de)

The components of the TG 500 system are licensed in accordance with EU Directive 2014/53/EU as follows:

“TG 1000 Beltpack Transmitter”

“TG 1000 Handheld Transmitter”

## 14. Simplified EU declaration of conformity

beyerdynamic hereby declares that the wireless transmission device complies with the EU Directive 2014/53/EU. The complete text of the EU declaration of conformity is available online at the following address:

<http://www.beyerdynamic.com/cod>

## FCC Regulation

**FCC ID:** OSDTG1000B for TG 1000 Beltpack Transmitter  
OSDTG1000H for TG 1000 Handheld Transmitter

**Canada IC:** 3628A-TG1000B for TG 1000 Beltpack Transmitter  
3628A-TG1000H for TG 1000 Handheld Transmitter  
3628A-TG1000X for TG 1000 Dual-Receiver

**NOTE:** This equipment has been tested and found to comply with the limits for a Class B digital device, pursuant to Part 15 of the FCC Rules. These limits are designed to provide reasonable protection against harmful interference in a residential installation. This equipment generates, uses and can radiate radio frequency energy and, if not installed and used in accordance with the instructions, may cause harmful interference to radio communications. However, there is no guarantee that interference will not occur in a particular installation. If this equipment does cause harmful interference to radio or television reception, which can be determined by turning the equipment off and on, the user is encouraged to try to correct the interference by one or more of the following measures:

- Reorient or relocate the receiving antenna.
- Increase the separation between the equipment and receiver.
- Connect the equipment into an outlet on a circuit different from that to which the receiver is connected.
- Consult the dealer or an experienced radio/TV technician for help.

**NOTICE:**

Changes or modifications made to this equipment not expressly approved by beyerdynamic GmbH & Co. KG may void the FCC authorization to operate this equipment.

**NOTICE:**

This device complies with Part 15 of the FCC Rules and with RSS-210 of Industry Canada. Operation is subject to the following two conditions:

- (1) this device may not cause harmful interference, and
- (2) this device must accept any interference received, including interference that may cause undesired operation.

**NOTICE:**

This Class B digital apparatus complies with Canadian ICES-003.  
Cet appareil numérique de la classe B est conforme à la norme NMB-003 du Canada.

**For USA:**

**OPERATION OF WIRELESS MICROPHONES IN THE 700 MHZ BAND IS PROHIBITED AFTER JUNE 12, 2010.**

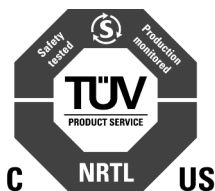

**CONSUMER ALERT**

Most users do not need a license to operate this wireless microphone system. Nevertheless, operating this microphone system without a license is subject to certain restrictions: the system may not cause harmful interference; it must operate at a low power level (not in excess of 50 milliwatts); and it has no protection from interference received from any other device.

Purchasers should also be aware that FCC is currently evaluating use of wireless microphone systems, and these rules are subject to change. For more information, call the FCC at 1-888-CALL-FCC (TTY: 1-888-TELL-FCC) or visit the FCC's wireless microphone website at [www.fcc.gov/cgb/wirelessmicrophones](http://www.fcc.gov/cgb/wirelessmicrophones).

**[www.beyerdynamic.com](http://www.beyerdynamic.com)**



**beyerdynamic GmbH & Co. KG**

Theresienstraße 8 · 74072 Heilbronn · Germany

For further distributors worldwide, please go to [www.beyerdynamic.com](http://www.beyerdynamic.com)

Non-contractual illustrations. Subject to change without notice.

Weitere Vertriebspartner weltweit finden Sie im Internet unter [www.beyerdynamic.com](http://www.beyerdynamic.com)

Abbildungen nicht vertragsbindend. Änderungen vorbehalten.

EN 17/ TG 1000 (04.19)